



TP CENTRAL ODISHA DISTRIBUTION LIMITED
(A Tata Power & Odisha Govt. joint venture)
2nd Floor, IDCO Tower, Janpath Bhubaneswar, Odisha 751022

NIT No.: TPCODL/P&S/1000000160/2021-22

Open Tender Notification

for

**Construction of Transformer repair shed at
Chowdar, Cuttack**

Tender Enquiry No.: TPCODL/P&S/1000000160/21-22

Due Date for Bid Submission: 22 January 2022 [15:00 Hrs.]

TP Central Odisha Distribution Limited
(A TATA Power and Odisha Government Joint Venture)
Procurement & Stores Department,
2nd Floor, IDCO Towers, Janpath, Bhubaneswar – 751022



TP CENTRAL ODISHA DISTRIBUTION LIMITED
(A Tata Power & Odisha Govt. joint venture)
2nd Floor, IDCO Tower, Janpath Bhubaneswar, Odisha 751022

NIT No.: TPCODL/P&S/1000000160/2021-22

**INFORMATION TO THE BIDDERS TO PARTICIPATE IN E-OPEN
TENDER SYSTEM OF TPCODL**

-: Steps for E-tender submission:-

Bids are to be submitted only through online e-procurement platform, ARIBA. Any other form of bid submission will not be accepted. Online Link for submission of bid through ARIBA will be sent only after confirmation of payment of tender fee from bidder.

Step 1: The bidder can get primary information about the tender from the Newspaper advertisement / TPCODL website <www.tpcentralodisha.com> and can download the tender document from the above website.

Step 2: Non-Refundable Tender Participation Fee, as indicated in tender document, to be submitted before last date of tender fee payment, in the form of direct deposit/NEFT/RTGS in the following bank account.

Account Name: TP Central Odisha Distribution Limited
Bank Name: State Bank of India,
IDCO Towers, Bhubaneswar
Bank Account No. : 10835304915
IFSC Code : SBIN0007891

Step 3: Eligible and Interested bidder to send an email to TPCODL attaching duly signed and stamped letter on Bidder's letterhead, with following details, expressing their intend to bid against above tender:

SI No	Description	Bidder's Response
i)	Tender Enquiry No.	
ii)	Description of materials / Works Tendered	
iii)	Name and address of the bidding company	
iv)	Name of the authorized contact person	
v)	Contact No. authorized person	
vi)	E-mail Id of the where online ARIBA link to be	
vii)	Tender Fee details (Amount / NEFT-RTGS UTR No	
viii)	GST No.of bidder	
ix)	MSME Certificate, wherever applicable	
x)	Postal address of bidder for return of EMD BG	

E-mail has to be sent to <asish.karmakar@tpcentralodisha.com> with copy to <sudhakar.behera@tpcentralodisha.com> before "Last date and time for payment of Tender Participation Fee".



TP CENTRAL ODISHA DISTRIBUTION LIMITED
(A Tata Power & Odisha Govt. joint venture)
2nd Floor, IDCO Tower, Janpath Bhubaneshwar, Odisha 751022

NIT No.: TPCODL/P&S/1000000160/2021-22

Step 4: On receipt of the document as mentioned in Step 3 above and after due verification of the same, ARIBA link for participation in the tender will be sent to bidder's mail address from ARIBA system.

Step 5: In this mail there will be an online link as **Click Here** to participate in the tender.

Step 6: Click **"Click Here"** to access this event.

Step 7: If bidder is bidding first time for TPCODL through ARIBA site then please "Sign UP" by creating User Name and password as mentioned in Sign Up page. Please follow the process, as mentioned in the Sign Up page, during creation of User Name and password. Also a simple one-page registration screen will open for first time user. All * mark mandatory field to be filled in.

Those who are already having User Name and password for accessing TPCODL events, they can LOGIN using same User Name and password.

If bidder has got User name and password for their other customer, same will not be applicable for TPCODL.

Step 8: You will be able to see the RFQ

Step 9: After review and downloading of all documents click on **"Review Pre-requisites"**

Step 10: Review and accept **"Bidder Agreement"**.

Step 11: You can see attached pdf tender document against clause no 1.1.1 (Introduction).

Step 12: Vendor has to attach pdf version of technical bid in clause no. 2.1 and 2.2. In this field do not attach any price document.

Price schedule is attached in clause no.3.2. Same has to be downloaded and price and tax details to be filled in as per the format given, print to be taken in vendor's letter head and signature and seal to be made by authorised person. PDF version of this price bid to be attached in clause 3.2 For Price Bid put all the unit price and taxes and duties in provided field. Put "0" (ZERO) in not applicable field.

Step 13: After successfully putting Techno commercial offer and price part then click on **"Submit Entire Response"**



TP CENTRAL ODISHA DISTRIBUTION LIMITED
(A Tata Power & Odisha Govt. joint venture)
2nd Floor, IDCO Tower, Janpath Bhubaneswar, Odisha 751022

NIT No.: TPCODL/P&S/1000000160/2021-22

CONTENTS OF THE ENQUIRY

S. NO.	PARTICULARS
1.	Event Information
2.	Submission of Bid Documents
3.	Bid Opening & Evaluation process
4.	Evaluation Criteria
5.	Award Decision
6.	Order of Preference/Contradiction
7.	Post Award Contract Administration
8.	Specifications and Standards
9.	General Conditions of Contract
10.	Safety
Annexures	
I	Annexure I – Schedule of Items
II	Annexure II – Specification, drawing and GTP
III	Annexure III – Schedule of Deviations
IV	Annexure IV – Schedule of Commercial Specifications
V	Annexure V – Document Check List
VI	Annexure VI – Acceptance Form for Participation in Reverse Auction Event
VII	Annexure VII – General Condition of Contract
VIII	Annexure VIII – Safety Policy and Safety Terms and Conditions
IX	Annexure IX - Environment & Sustainability Policy
X	Annexure X – Tata Code of Conduct(TCOC)



TP CENTRAL ODISHA DISTRIBUTION LIMITED
(A Tata Power & Odisha Govt. joint venture)
2nd Floor, IDCO Tower, Janpath Bhubaneshwar, Odisha 751022

NIT No.: TPCODL/P&S/1000000160/2021-22

1.0 Event Information

1.1. Scope of work

Open Tenders are invited from interested Bidders for the following work:

S. No.	Description	Quantity	Tender fee (incl GST), Rs	EMD (Rs)
1.	Construction of Transformer repair shed at Chowdar, Cuttack	As per enclosed BOQ, Annexure I	5,000	2,00,000

1.2. Availability of Tender Documents

Please refer “information to bidders to participate in E-Open tenders”, provided in the beginning of this tender document.

1.3. Calendar of Events

(a)	Date of availability of tender documents from TPCODL Website	01.01.2022
(b)	Last date and time of Payment of Tender Fee	05.01.2022, 17:00 Hours
(c)	Last Date of receipt of pre-bid queries, if any	12.01.2022, 17:00 Hours
(d)	Last Date of Posting Consolidated replies to all the pre-bid queries as received	15.01.2022, 17:00 Hours
(e)	Last date and time of receipt of Bids	22.01.2022, 15:00 Hours

Note: In the event of last date specified for submission of bids and date of opening of bids is declared as a closed holiday for TPCODL’s office, the last date of submission of bids and date of opening of bids will be the day following working day at appointed times.

1.4 Mandatory documents required along with the Bid

- 1.4.1 EMD of requisite value and validity.
- 1.4.2 Tender Fee
- 1.4.3 Requisite Documents for compliance to Qualification Criteria mentioned in Clause 1.7.
- 1.4.4 Acceptance of Specification as per Annexure II.
- 1.4.5 Duly signed and stamped ‘Schedule of Deviations’ as per Annexure III on bidder’s letter head.
- 1.4.6 Duly signed and stamped ‘Schedule of Commercial Specifications’ as per Annexure IV on bidder’s letter head.
- 1.4.7 Duly filled in Annexure V and VI.
- 1.4.8 Proper authorization letter/ Power of Attorney to sign the tender on the behalf of bidder.
- 1.4.9 Copy of PAN, GST registration (In case any of these documents is not available with the bidder, same to be explicitly mentioned in the ‘Schedule of Deviations’)



TP CENTRAL ODISHA DISTRIBUTION LIMITED
(A Tata Power & Odisha Govt. joint venture)
2nd Floor, IDCO Tower, Janpath Bhubaneswar, Odisha 751022

NIT No.: TPCODL/P&S/1000000160/2021-22

Please note that in absence of any of the above documents, the bid submitted by a bidder shall be liable for rejection.

1.5. Deviation from Tender

Normally, the deviations to tender terms are not admissible and the bids with deviation are liable for rejection. Hence, the bidders are advised to refrain from taking any deviations on this Tender. Still in case of any deviations, all such deviations shall be set out by the Bidders, clause by clause in the 'Annexure III - Schedule of Deviations' and same shall be submitted as a part of the Technical Bid.

1.6. Right of Acceptance/Rejection

Bids are liable for rejection in absence of following documents:

- i. EMD of requisite value and validity
- ii. Tender fee of requisite value.
- iii. Price Bid as per the Price Schedule mentioned in Annexure I (BOQ)
- iv. Necessary documents against compliance to Qualification Requirements mentioned at Clause 1.7 of this Tender Document.
- v. Filled in Schedule of Deviations as per Annexure III.
- vi. Filled in Schedule of Commercial Specifications as per Annexure IV.
- vii. Signed specification as per Annexure II.
- viii. Duly filled and signed Annexure V and VI.
- ix. Receipt of Bid within the due date and time.

TPCODL reserves the right to accept/reject any or all the bids without assigning any reason thereof.

1.7 Qualification Criteria

- a) The bidder should have an average annual turnover of Rs.1.8 crore in last three financial years. Copy of audited Balance Sheet and P&L Account to be submitted in this regard.
- b) The bidder should have experience in construction of similar store building in last five years. Bidder should submit order copies and completion certificate to this effect.
- c) The bidder must have all statutory compliance like valid PAN no., GSTN, PF & ESI. The bidder must submit the copy of all these registrations.

1.8. Marketing Integrity

We have a fair and competitive marketplace. The rules for bidders are outlined in the General Condition of Contracts. Bidders must agree to these rules prior to participating. In addition to other remedies available, TPCODL reserves the right to exclude a bidder from participating in future markets due to the bidder's violation of any of the rules or obligations contained in the General Condition of Contracts. A bidder who violates the market place rules or engages in behavior that disrupts the fair execution of the marketplace, may result in restriction of a bidder from further participation in the marketplace for a length of time, depending upon the seriousness of the violation. Examples of violations include, but are not limited to:

- Failure to honor prices submitted to the marketplace
- Breach of terms as published in TENDER/NIT

1.9. Supplier Confidentiality



TP CENTRAL ODISHA DISTRIBUTION LIMITED
(A Tata Power & Odisha Govt. joint venture)
2nd Floor, IDCO Tower, Janpath Bhubaneswar, Odisha 751022

NIT No.: TPCODL/P&S/1000000160/2021-22

All information contained in this tender is confidential and shall not be disclosed, published or advertised in any manner without written authorization from TPCODL. This includes all bidding information submitted to TPCODL. All tender documents remain the property of TPCODL and all suppliers are required to return these documents to TPCODL upon request. Suppliers who do not honor these confidentiality provisions will be excluded from participating in future bidding events.

2.0 Evaluation Criteria

- The bids will be evaluated technically on the compliance to tender terms and conditions.
- The bids will be evaluated commercially on overall aggregate value (all-inclusive lowest cost) for the complete tender as calculated in Schedule of Items [Annexure I].
- Bidder has to mandatorily quote against each item of Schedule of Items [Annexure I]. Failing to do so, TPCODL may reject the bids.

NOTE: In case a new bidder is not registered with TPCODL, factory inspection and evaluation shall be carried out to ascertain bidder's manufacturing capability and quality procedures. However, TPCODL reserves the right to carry out factory inspection and evaluation for any bidder prior to technical qualification.

In case a bidder is found as Disqualified in the factory evaluation, their bid shall not be evaluated any further and shall be summarily rejected. The decision of TPCODL shall be final and binding on the bidder in this regard.

2.1 Price Variation Clause: The prices shall remain firm during the entire contract period.

2.2 Quantity Variation Clause: Quantities mentioned in Annexure I are indicative. Same may vary on either side.

3.0 Submission of Bid Documents

3.1 Bid Submission

Bidders are requested to submit their offer in line with this Tender document through e-tendering process.

Please note all future correspondence regarding the tender, bid submission, bid submission date extension, Pre-bid query etc. will happen only through TPCODL E-Tender system (Ariba).

No e-mail or verbal correspondence will be responded. All communication will be done strictly with the bidder who have done the above step to participate in the Tender.

Bids shall be submitted in 3(Three) parts:

FIRST PART: FIRST PART: "EMD" as applicable shall be submitted. The EMD shall be valid for 210 days from the due date of bid submission in the form of Bank Guarantee / Bank Draft / Bankers Pay Order (issued from a Scheduled Bank) online NEFT/ RTGS transfer favoring 'TP Central Odisha Distribution Limited' payable at Bhubaneswar. The EMD BG has to be strictly in the format as mentioned in General Condition of Contract, failing which it shall not be accepted by TPCODL and the bid as submitted shall be liable for rejection. A separate non-refundable tender fee of stipulated amount also needs to be transferred online through NEFT/ RTGS in case the tender document is downloaded from our website.

TPCODL Bank Details for transferring Tender Fee and EMD is as below:



TP CENTRAL ODISHA DISTRIBUTION LIMITED
(A Tata Power & Odisha Govt. joint venture)
2nd Floor, IDCO Tower, Janpath Bhubaneswar, Odisha 751022

NIT No.: TPCODL/P&S/1000000160/2021-22

Account Name: TP CENTRAL ODISHA DISTRIBUTION LIMITED
Bank Name: SBI, IDCO Towers, Bhubaneswar
Bank Account No.: 10835304915
IFSC Code: SBIN007891

Note- EMD is preferred in form of Bank Guarantee and to be delivered at the following address. However, in view of present situation if Bidder is finding it difficult to make and submit BG for EMD amount, they can do online transfer of EMD amount in the above mentioned Account and submit proof of the same as part of Bid Submission.

Please note that in such case, Tender Fee and EMD should be strictly 2 separate transactions. Please note as return of EMD from Bank Account is non-standard practice the same may take more time than return of EMD BG.

EMD Original Hard Copy shall be delivered at the following address in Envelope clearly indicating Tender Reference/ Enquiry Number, Name of Tender and Bidder Name

Chief (Procurement & Stores)
TP Central Odisha Distribution Limited
2nd Floor, IDCO Towers, Janapath, Bhubaneswar- 751022

SECOND PART: "TECHNICAL BID" shall contain the following documents:

- i) Requisite Documents for compliance to Qualification Criteria mentioned in Clause 1.7.
- ii) Acceptance of Specification.
- iii) Duly signed and stamped 'Schedule of Deviations' as per Annexure III on bidder's letter head.
- iv) Duly signed and stamped 'Schedule of Commercial Specifications' as per Annexure IV on bidder's letter head.
- iv) Duly filled in Annexure V and VI.
- vi) Proper authorization letter/ Power of Attorney to sign the tender on the behalf of bidder.
- vii) Copy of PAN, GST registration (In case any of these documents is not available with the bidder, same to be explicitly mentioned in the 'Schedule of Deviations')

The technical bid shall be properly indexed and is to be submitted through TPCODL E-tender System (Ariba) only. Hard Copy of Technical Bids need not be submitted

THIRD PART: "PRICE BID" shall contain only the price details and strictly in format as mentioned in Annexure I along with explicit break up of basic prices, Taxes & duties, Freight etc. In case any discrepancy is observed between the item description stated in Schedule of Items mentioned in the tender and the price bid submitted by the bidder, the item description as mentioned in the tender document (to the extent modified through Corrigendum issued if any) shall prevail.

Price Bid is to be submitted in soft copy through TPCODL E-Tendering system (Ariba) only. Hard copy of Price Bid not be submitted

The EMD in the form of Bank Draft / BG / Bankers Pay Order shall be submitted in original hard copy and then placed in sealed envelope which shall be clearly marked as below:

EMD

"RATE CONTRACT FOR SUPPLY OF PSC POLE, TENDER NO 1000000160"



TP CENTRAL ODISHA DISTRIBUTION LIMITED
(A Tata Power & Odisha Govt. joint venture)
2nd Floor, IDCO Tower, Janpath Bhubaneswar, Odisha 751022

NIT No.: TPCODL/P&S/1000000160/2021-22

The Bid prepared by the Bidder, and all correspondence and documents relating to the Bid exchanged by the Bidder and the TPCODL, shall be written in the English Language. Any printed literature furnished by the Bidder may be written in another Language, provided that this literature is accompanied by an English translation, in which case, for purposes of interpretation of the Bid, the English translation shall govern.

SIGNING OF BID DOCUMENTS:

The bid must contain the name, residence and place of business of the person or persons making the bid and must be signed and sealed by the Bidder with his usual signature. The names of all persons signing should also be typed or printed below the signature.

The Bid being submitted must be signed by a person holding a Power of Attorney authorizing him to do so, certified copies of which shall be enclosed.

The Bid submitted on behalf of companies registered with the Indian Companies Act, for the time being in force, shall be signed by persons duly authorized to submit the Bid on behalf of the Company and shall be accompanied by certified true copies of the resolutions, extracts of Articles of Association, special or general Power of Attorney etc. to show clearly the title, authority and designation of persons signing the Bid on behalf of the Company. Satisfactory evidence of authority of the person signing on behalf of the Bidder shall be furnished with bid.

A bid by a person who affixes to his signature the word 'President', 'Managing Director', 'Secretary', 'Agent' or other designation without disclosing his principal will be rejected.

The Bidder's name stated on the Proposal shall be the exact legal name of the firm.

3.2 Contact Information

All the bidders are requested to send their pre-bid queries (if any) against this tender through e-mail within the stipulated timelines. The consolidated reply to all the queries received shall be posted on TPCODL website by the stipulated timelines as detailed in calendar of events.

Communication Details:

Handling Executive for this Tender:

Name: Asish Karmakar
Contact No.: 8768455566
E-Mail ID: asish.karmakar@tpcentralodisha.com

General Manager (Material Procurement):

Name: Mr. Sudhakar Behera
Contact No.: 9437282663
E-Mail ID: sudhakar.behera@tpcentralodisha.com

3.3 Bid Prices

Bidders need to quote for all items as per the Price schedule attached in Annexure I. The bidder shall complete the appropriate Price Schedules included herein, stating the Unit Price for each item & total price with taxes, duties & freight up to destination at various sites of TPCODL. The all-inclusive prices offered shall be inclusive of all costs as well as Duties, Taxes and Levies paid or payable during the execution of the supply work, breakup of price constituents.

Applicable GST to be specified clearly.



TP CENTRAL ODISHA DISTRIBUTION LIMITED
(A Tata Power & Odisha Govt. joint venture)
2nd Floor, IDCO Tower, Janpath Bhubaneswar, Odisha 751022

NIT No.: TPCODL/P&S/1000000160/2021-22

The quantity break up shown else-where other than Price Schedule is tentative. The bidder shall ascertain himself regarding material required for completeness of the entire work. Any items not indicated in the price schedule but which are required to complete the job as per the Technical Specifications/ Scope of Work/ SLA mentioned in the tender, shall be deemed to be included in prices quoted.

3.4 Bid Currencies

Prices shall be quoted in Indian Rupees Only.

3.5 Period of Validity of Bids

Bids shall remain valid for 180 days from the due date of submission of the bid.

Notwithstanding clause above, the TPCODL may solicit the Bidder's consent to an extension of the Period of Bid Validity. The request and responses thereto shall be made in writing.

RC Validity: - The validity of this rate contract shall be one year from the date of issuance.

3.6 Alternative Bids

Bidders shall submit Bids, which comply with the Bidding documents. Alternative bids will not be considered. The attention of Bidders is drawn to the provisions regarding the rejection of Bids in the terms and conditions, which are not substantially responsive to the requirements of the bidding documents.

3.7 Modifications and Withdrawal of Bids

The bidder is not allowed to modify or withdraw its bid after the Bid's submission. The EMD as submitted along with the bid shall be liable for forfeiture in such event.

3.8 Earnest Money Deposit (EMD)

The bidder shall furnish, as part of its bid, an EMD amounting as specified in the tender. The EMD is required to protect TPCODL against the risk of bidder's conduct which would warrant forfeiture.

The EMD shall be denominated in any of the following form:

- Banker's Cheque/ Demand Draft/ Pay order drawn in favor of TP Central Odisha Distribution Limited payable at Bhubaneswar.
- Online transfer of requisite amount through NEFT/ RTGS.
- Bank Guarantee valid for 210 days after due date of submission.

The EMD shall be forfeited in case:

- a) The bidder withdraws its bid during the period of specified bid validity.

Or

- b) The successful Bidder does not
- a) accept the Purchase Order, or
 - b) furnish the required Performance Security Bank Guarantee

3.9 Type Tests (if applicable)

The type tests specified in TPCODL specifications should have been carried out within five years prior to the date of opening of technical bids and test reports are to be submitted along with the bids. If type tests carried out are not within the five years prior to the date of bidding,



TP CENTRAL ODISHA DISTRIBUTION LIMITED
(A Tata Power & Odisha Govt. joint venture)
2nd Floor, IDCO Tower, Janpath Bhubaneswar, Odisha 751022

NIT No.: TPCODL/P&S/1000000160/2021-22

the bidder will arrange to carry out type tests specified, at his cost. The decision to accept/reject such bids rests with TPCODL

4 Bid Opening & Evaluation process

4.1. Process to be confidential

Information relating to the examination, clarification, evaluation and comparison of Bids and recommendations for the award of a contract shall not be disclosed to Bidders or any other persons not officially concerned with such process. Any effort by a Bidder to influence the TPCODL's processing of Bids or award decisions may result in rejection of the Bidder's Bid.

4.2. Technical Bid Opening

Bids will be opened at TPCODL Office, Bhubaneswar. All tender bids shall be opened internally by TPCODL. Presence of any bidder will not be allowed during bid opening process. Technical bid must not contain any cost information whatsoever.

First the envelope marked "EMD" will be opened. Bids without EMD/cost of tender (if applicable) of required amount/ validity in prescribed format, shall be rejected.

Next, the technical bid of the bidders who have furnished the requisite EMD will be opened, one by one.

4.3. Preliminary Examination of Bids/Responsiveness

TPCODL will examine the Bids to determine whether they are complete, whether any computational errors have been made, whether required sureties have been furnished, whether the documents have been properly signed, and whether the Bids are generally in order. TPCODL may ask for submission of original documents in order to verify the documents submitted in support of qualification criteria.

Arithmetical errors will be rectified on the following basis: If there is a discrepancy between the unit price and the total price per item that is obtained by multiplying the unit price and quantity, the unit price shall prevail and the total price per item will be corrected. If there is a discrepancy between the Total Amount and the sum of the total price per item, the sum of the total price per item shall prevail and the Total Amount will be corrected.

Prior to the detailed evaluation, TPCODL will determine the substantial responsiveness of each Bid to the Bidding Documents including production capability and acceptable quality of the Goods offered. A substantially responsive Bid is one, which conforms to all the terms and conditions of the Bidding Documents without material deviation.

Bid determined as not substantially responsive will be rejected by the TPCODL and may not subsequently be made responsive by the Bidder by correction of the non-conformity.

4.4. Techno Commercial Clarifications

Bidders need to ensure that the bids submitted by them are complete in all respects. To assist in the examination, evaluation and comparison of Bids, TPCODL may, at its discretion, ask the Bidder for a clarification on its Bid for any deviations with respect to the TPCODL specifications and attempt will be made to bring all bids on a common footing. All responses to requests for clarification shall be in writing and no change in the price or substance of the Bid shall be sought, offered or permitted owing to any clarifications sought by TPCODL.

4.5. Price Bid Opening

Price bids will be opened internally without the presence of any bidder representative. The EMD of the bidder withdrawing or substantially altering his offer at any stage after the technical

Property of TPCODL – Not to be reproduced without prior written permission of TPCODL



TP CENTRAL ODISHA DISTRIBUTION LIMITED
(A Tata Power & Odisha Govt. joint venture)
2nd Floor, IDCO Tower, Janpath Bhubaneshwar, Odisha 751022

NIT No.: TPCODL/P&S/1000000160/2021-22

bid opening will be forfeited at the sole discretion of TPCODL without any further correspondence in this regard.

4.6. Reverse Auctions

TPCODL reserves the right to conduct the reverse auction (instead of public opening of price bids) for the products/ services being asked for in the tender. The terms and conditions for such reverse auction events shall be as per the Acceptance Form attached as Annexure VI of this document. The bidders along with the tender document shall mandatorily submit a duly signed copy of the Acceptance Form attached as Annexure VI as a token of acceptance for the same.

5 Award Decision

TPCODL will award the contract to the successful bidder whose bid has been determined to be the lowest-evaluated responsive bid as per the Evaluation Criterion mentioned at Clause 2.0. The Cost for the said calculation shall be taken as the all-inclusive cost quoted by bidder in Annexure I (Schedule of Items) subject to any corrections required in line with Clause 3.2 above. The decision to place purchase order/LOI solely depends on TPCODL on the cost competitiveness across multiple lots, quality, delivery and bidder's capacity, in addition to other factors that TPCODL may deem relevant.

TPCODL reserves the rights to award contract to one or more bidders so as to meet the delivery requirement or nullify award decision without assigning any reason thereof.

In case any supplier is found unsatisfactory during delivery process, the award will be cancelled and TPCODL reserves right to award contract to other suppliers who are found fit.

6 Order of Preference/Contradiction

In case of contradiction in any part of various documents in tender, following shall prevail in order of preference:

1. Schedule of Items (Annexure I)
2. Post Award Contract Administration (Clause 7.0)
3. Submission of Bid Documents (Clause 3.0)
4. Technical Specifications (Annexure II)
5. Acceptance Form for Participation in Reverse Auction (Annexure VI)
6. General Conditions of Contract (Annexure VIII)

7 Post Award Contract Administration

7.1. Special Conditions of Contract

- Contract shall be valid for a period of 1 year from the placement of Contract. Release Order (RO) shall be placed as per the requirement of TPCODL. Rate shall remain FIRM till the validity of Rate Contract.
- Price to be quoted as per BOQ, Annexure I.
- Approved make of materials will be as per Annexure II.
- General layout drawing and foundation layout drawing is enclosed.
- All rates of supply items are to be quoted on delivered basis.



TP CENTRAL ODISHA DISTRIBUTION LIMITED
(A Tata Power & Odisha Govt. joint venture)
2nd Floor, IDCO Tower, Janpath Bhubaneshwar, Odisha 751022

NIT No.: TPCODL/P&S/1000000160/2021-22

- Business Associate (BA) shall submit applicable Performance Bank Guarantee as per GCC within 30 days of issuance of order. PBG applicable shall be 5% of Rate Contract Value. PBG submitted, should be valid till completion of applicable warranty period plus additional claim period.
- Any change in statutory taxes, duties and levies during the contract period shall be borne by TPCODL. However, in case of delay in work execution owing to reasons not attributable to TPCODL, any increase in total liability shall be passed on the Bidder, whereas any benefits arising owing to such statutory variation in taxes and duties shall be passed on TPCODL.
- Statutory Variations: Any changes in existing taxes/ Duties and levies, Introduction of new taxes and duties etc. during the period of the contract shall be paid at actuals to BA subject to BA shall submit the tax break up in details, however, where BA has quoted the all-inclusive prices and not shown the tax break-up, this clause will not be applicable. The date of issue of MDCC shall be used for this purpose.
- Quotation in all BOM items is mandatory, and bid shall be rejected if any line of found blank in price bid.
- There will be no price escalation given to bidder after issue the RC.
- Delivery period shall be 180 days from date of receipt of release order / site clearance, whichever is later
- Warranty period: 12 months from date of date of completion of work
- All other terms and conditions of TPCODL General Conditions of Contract shall be applicable.
- TPCODL shall short close the issued Release Order / Rate contract, in case of any quality issues
- Terms of Payment:
 - 100% payment of Running Account(RA) bills(each bill not less than Rs 25 Lac value) shall be released within 15 days from the date of submission of certified bills/ invoices. 100% payment of final bill shall be released within 30 days from the date of submission of certified bills/ invoices with complete details and fulfilment of statutory compliances and other requirements, if any.Frequency of RA bill, if applicable, will be mentioned in RO.

7.2 Drawing Submission and Approval(If applicable)

The relevant drawings need to be submitted within two weeks of receipt of firm purchase order by the successful bidder to TPCODL for approval. In case, re-submission of drawings is required on request of TPCODL, same needs to be submitted back to TPCODL within 5 days of such request.

7.3 Payment Terms

As per SCC, clause number 7.1.

7.4 Climate Change

Significant quantities of waste are generated during the execution of project and an integrated approach for effective handling, storage, transportation and disposal of the same shall be adopted. This would ensure the minimization of environmental and social impact in order to



TP CENTRAL ODISHA DISTRIBUTION LIMITED
(A Tata Power & Odisha Govt. joint venture)
2nd Floor, IDCO Tower, Janpath Bhubaneswar, Odisha 751022

NIT No.: TPCODL/P&S/1000000160/2021-22

combat the climate change. Please refer attached Environment Policy and Sustainability Policy, enclosed herewith, for more details.

7.5 Ethics

TPCODL is an ethical organization and as a policy TPCODL lays emphasis on ethical practices across its entire domain. Bidder should ensure that they should abide by all the ethical norms and in no form either directly or indirectly be involved in unethical practice.

TPCODL work practices are governed by the Tata Code of Conduct which emphasizes on the following:

- We shall select our suppliers and service providers fairly and transparently.
- We seek to work with suppliers and service providers who can demonstrate that they share similar values. We expect them to adopt ethical standards comparable to our own.
- Our suppliers and service providers shall represent our company only with duly authorized written permission from our company. They are expected to abide by the Code in their interactions with, and on behalf of us, including respecting the confidentiality of information shared with them.
- We shall ensure that any gifts or hospitality received from, or given to, our suppliers or service providers comply with our company's gifts and hospitality policy.
- We respect our obligations on the use of third party intellectual property and data.

Bidder is advised to refer Tata Code of Conduct (TCOC) attached for more information.

Any ethical concerns with respect to this tender can be reported to the following e-mail ID:

ravindra.singh@tpcentralodisha.com and Pravin.jain@tpcentralodisha.com

8 Specification and standards

As per Annexure II

9 General Condition of Contract

Any condition not mentioned above shall be applicable as per GCC attached along with this tender.

10 Safety

All jobs under this tender have to be executed strictly in compliance to the Safety terms and Conditions of TP Central Odisha Distribution Limited. Please refer attached Safety terms and conditions, Annexure-VII, for details. Violation of Safety norms will result in Penalty as mentioned in the above document.

Annexure-I, Price Schedule

Workshop Building at Chowdar at TPCODL							
BILL OF QUANTITIES TABLE 1- GENERAL CIVIL WORKS							
Sr. No.	Description	A	B	C	D	E=(C+D)	F=E x D
I	EARTHWORK	Quantity	Unit	Rate (Rs)	GST (Rs)	Rate with GST(Rs)	Amount (Rs)
1	Excavation below existing Ground Level for foundations, drains or any other structure within the OWNER's Premises in ordinary earth, soft/weathered rock, which includes rock/boulders/slag/slate/laterite, and/ gravel/ clay/ murrum of all kinds, rubble, concrete debris, scrap steel, clearing away vegetation trees of all girth, bushes, underground roots, stumps etc., including shoring, strutting and all safety provisions, by providing adequate slopes using hard barricading as per OWNER's standards including removing vegetation, shrubs, including careful handling of underground utilities etc., stacking and multiple handling of earth within the OWNER's Premises <u>and disposal of surplus earth outside the Owner's Premises</u> as directed by Engineer-in-charge, including dewatering, preparing the bed for foundation etc. The rate quoted shall be inclusive of the above works and also include those for statutory permission. Payment for earth works shall be on net plan area of PCC. No payment will be made for side slopes, working area etc.						
(i)	From existing ground level to a depth of 2 m	801.90	Cum				
2	Filling Available Excavated earth Filling available excavated earth (excluding rock) trenches, plinth, sides of foundations etc. in layers not exceeding 20 cm in depth: consolidating each deposited layer by ramming watering, lead up to 50 m and lift upto 1.5 m	320.76	Cum				

3	<p>River Sand Supplying and filling in plinth with River sand under floors including, watering, ramming, consolidating and dressing complete</p>	103.36	Cum				
4	<p>Providing & laying dry trap granite/quartzite/gneiss/rubble stone soling with maximum 230mm size hard stone set in regular lines, hand packed and interstices thoroughly filled with small chips including filling in with good quality murum and compacted with 8 to 10 tonne rollers and spreading 12mm thick layer of grit on top, etc. complete in all aspects as directed by the Engineer-in-Charge.</p>	118.86	Cum				
5	<p>Supplying and Providing pre-constructional anti-termite treatment, and creating a chemical barrier, under and on sides of trenches, wall footings, top surface of plinth filling, including junction of wall and floor along the perimeter of building, with approved emulsifiable insecticides at the rates and concentrations as per IS.6313 (Part-II) and as directed by Engineer. (Treated plinth area of the building at ground floor only shall be measured) (Contractor to submit guarantee on Rs. 1000 stamp paper, guaranteeing against termite attack for a period of 5 years.)</p>	800.00	Sqm				
6	<p>Plinth Protection Making plinth protection 50 mm thick of cement concrete 1:3:6 (1 cement : 3 coarse sand (zone-III) : 6 graded stone aggregate 20 mm nominal size) over 75 mm bed of dry brick ballast 40 mm nominal size well rammed and consolidated and grouted with fine sand including finishing with cement punning.</p>	66.00	Sqm				
II	CONCRETE AND ALLIED WORKS						
7	<p>CC 1:3:6 (coarse sand) Providing and laying in position cement concrete of specified grade excluding the cost of centring and shuttering- All work upto plinth level: 1:3:6 (1 cement : 3 coarse sand (zone-III) : 6 graded stone aggregate 20 mm nominal size)</p>	90.62	Cum				

8	Providing and placing in position Ready Mix Concrete of M25 grade for all shapes, at all levels above or below ground including admixtures if any, centering, shuttering, scaffolding, vibrating, compacting, curing, dewatering, levelling, cutouts, openings, finishing, removal of formwork, etc. complete, for all lead and lifts, to obtain class F1 finish with leak proof concrete as per specifications/drawings and as directed by the Engineer- in-Charge for the following items (excluding reinforcement and structural steel):					
(i)	All foundations & base raft	93.09	Cum			
(ii)	RCC columns, pedestals, brackets, walls	85.39	Cum			
(iii)	RCC slabs, staircase steps, waist slabs,	28.44	Cum			
(iv)	RCC Beams, lintels, chajjas, etc.	128.30	Cum			
9.0	Grade Slab Providing and laying in position Ready Mix Concrete of M25 grade excluding the cost of centring and shuttering- All work upto plinth level : 1:1:2 (1cement : 1 coarse sand (zone-III) : 2 graded stone aggregate 20 mm nominal size. (excluding cost of reinforcement)	85.27	Cum			
III	STEEL WORKS					
10	Supply, Cleaning, cutting, bending, as per drawings and placing in position High yield strength deformed reinforcement bars conforming to IS: 1786 at all locations and levels including binding with soft annealed 18G black wire, etc. Complete as shown on drawings and as directed by the Engineer (No payment will be made for staper bar, layer pin, chair, tie rods and other supports, binding wires, laps)					
	a) For HYSD bars conforming to grade Fe 500 of IS 1786	60.31	MT			
IV	STRUCTURAL STEEL WORKS					

11	<p>Supplying, detailing, fabricating, transporting to site of erection, erecting in position at all levels, alignment and final site welding/bolting of all structural components fabricated out of steel conforming IS 2062 including all connected operations such as but not limited to collection of steel from OWNER, straightening of plates, preparation of cutting plans, cutting, bending, grinding, drilling of holes, assembly, bolting (supply of permanent bolt and nut to be paid for separately under relevant item) providing erection bolts and nut (weight not considered for payment) welding (weight not considered for payment) including, edge preparation for welding, pre heating of plates before welding, post heating, sequencing of welding, testing of welders, inspection and testing of welds, rectification/ correction of defective welds, etc complete including providing erection mark, erection scheme, protection against damage in transit, ensuring stability of structure by installing temporary structure (weight not payable) during erection, including supply of all skilled labour, material, consumables, handling equipment, during fabrication and erection and all other activities, required for complete work as per specification, construction drawings and instruction of ENGINEER (cost of preparation of surface and painting will be paid for extra against relevant items)</p>					
a	<p>Structural steel member fabricated out of rolled steel sections only and rolled steel section with cover plates conforming to Grade E 250 (Fe 410W) quality A of IS2062, such as columns, beams, trusses, vertical and horizontal bracings, tie beams, struts, purlins, side girts, sag rods, hangers, mono rail</p>	25.16	MT			

	beam, stub column, walkways, platforms, stair stringers, ladders.						
12	Painting of structural steel						
	Providing and applying high performance phenolic based paint with micaceous iron oxide painting system of approved colour and shade consisting of Zinc phosphate primer, intermediate (under) coat, finish coat and final finish coat including shot blast cleaning of steel surfaces to near white metal surface (Sa 2½), to steel surfaces of all types, shapes and sizes, at all levels, to achieve an even shade, including all labour, material, consumables equipment, handling, transportation, protection and cleaning, scaffolding and staging, testing, etc., all complete, as per specifications, drawings and instructions of the Engineer.						
a	Blast cleaning by shot / metal blasting of steel surfaces to near white metal surface (Sa 2½) and applying Inorganic Zinc Phosphate primer of minimum 40 micron (DFT) (2 coats) , including touch up painting for the damaged surfaces of primer.	25.16	MT				
b	Applying intermediate (under) coat over inorganic Zinc Phosphate primer, (excluding cost of primer), consisting of minimum 75 micron DFT single pack high phenolic based paint with micaceous iron oxide(M10) including touch up painting for the damaged surfaces of intermediate paint.	25.16	MT				

c	Applying finish coat over Intermediate (under) coat, (excluding cost of Intermediate coat), consisting of minimum 25 micron DFT single pack air drying high gloss phenolic alkyd modified synthetic enamel paint suitably pigmented (2 coats) including final touch up painting for the damaged surfaces of Finish except steel doors and windows indoor / outdoor.	25.16	MT				
d	Applying top finish coat using polyurethane enamel of high gloss and hard finish suitably pigmented of 30 micron DFT for UV protection over Finish coat for steel doors and windows indoor / outdoor.	25.16	MT				
13	Supplying, Detailing, fabricating and transporting to site and erecting miscellaneous steel components conforming to IS: 2062, such as but not limited to MS grills, ladders, plates, MS rungs, all types of plate inserts and embedment's with lugs, pipe hangers / supports, pipe hoods, pipe sleeves, edge protection angles, tie rods, anchor bars, anchor channels etc. Including welding etc. Complete with preparation of surfaces and providing two shop coat of red oxide zinc phosphate primer and touch up coat of red oxide zinc phosphate primer after erection as per specifications and approved fabrication drawings.	2.00	MT				
V	MISC WORKS						
14	Supplying fitting & fixing in position 0.6mm thick,High strength steel sheet ,1015 mm wide coverage profile with nominal 28.5mm deep ribs. zinc aliminium coated,minimum yeild stress 550 Mpa. Minimum coating mass 150 g/sqm or approved equivalent (including ridge tile and wall cladding). Item is including of moulding of edges all around.	644.96	Sqm				

15	Providing, fixing and jointing UPVC rain water down take pipes conforming to IS:4985 class 3 of the following diameters with standard fixing clamps including special fittings such as bends, shoes, junctions, swan necks, etc. complete					
(ii)	150mm UPVC Pipe	150.00	RM			
16	Providing G.I. rain water gutters of matching colour to the roof sheet for conveying the rain water to the UPVC Downtake pipes including provision of necessary outlet to connect the pipe, clamps etc. complete.	70.00	RM			
17	Supplying, installation of heavy duty turbo ventillators fit for workshop/factories in brickwork/profile sheeting, material of weather resisting coating on aluminium of 24"/600 mm diameter automatic type including fitting, fixing and cutting wall/roofs, finishing gaps with sealant etc as required and wiring complete as per direction and approval of Engineer-Incharge.	8.00	Nos.			
A	Masonry, plaster, painting, doors, flooring,					
18	Brick Work brick masonry 230 mm thick Providing all material and constructing fly ash brick masonry 230 mm thick and above in cement mortar (1:6) using approved quality including scaffolding, curing, raking joints, etc. complete as per specifications & drawings at all levels & locations.	168.36	cum			
19	Brick Work masonry 115 mm thick Providing all material and constructing fly ash brick masonry 115 mm thick and above in cement mortar (1:6) using approved quality including scaffolding, curing, raking joints, etc. complete as per specifications & drawings at all levels & locations.	40.00	sqm			

20	<p>Half Brick Masonry(6mm dia MS Bar) Extra for providing and placing in position 2 Nos. 6mm dia. M.S. bars at every third course of half brick masonry.</p>	40.00	sqm				
21	<p>Providing and applying three coats of emulsion (washable) external weathercoat paint of Asian make ACE / Nerolac Suraksha / ICI Dulux Super Coat with required shade over a coat of primer on all exterior surfaces including cleaning, curing, all scaffolding, etc., complete as per manufacturer's specifications and as directed by the Engineer. Rate to be applicable for all heights and levels surfaces and textures. No extra payable for extra paint consumption due to surface texture.</p>	268.00	sqm				
22	<p>Acrylic Emulsion paint of internal grade: Providing and applying two coats of first quality Acrylic Emulsion paint of interior grade having VOC contain less the 50 gm/lit of approved colour and shade over one coat of primer and finishing coats, providing and applying primer, any additional coat required to achieve even shade and colour including cleaning, curing, all scaffolding, etc. complete. Rate to be applicable for all heights and level surface and texture.</p>	172.00	sqm				
23	<p>Synthetic Enamel Paint (New work): Painting with synthetic enamel paint of approved brand and manufacture to give an even shade of approved colour and shade over one coat of primer and finishing coats, providing and applying primer, any additional coat required to achieve even shade and</p>	230.00	sqm				

	colour including cleaning, curing, all scaffolding, etc. complete. Rate to be applicable for all heights and level surface and texture: Two or more coats on new work.					
24	Providing and applying of 1 to 2 mm thick Cement Putty over all types of plastered surfaces of walls ceiling beams columns etc. to bring surface in plumb line and level, including making surface smooth, providing required grooves on top of skirting etc. The cost shall include all labor, materials, scaffolding, protecting adjoining surface, cleaning etc. complete.	402.00	sqm			
25	Providing internal cement plaster 12 mm thick plain finish in single coat in cement mortar 1:4, in all positions with hacking, surface preparation, including scaffolding and curing, grooves, bands, drip moulds, including providing and fixing chicken mesh of 22 gauge, with about 15 cm width of approved quality at the junction of reinforced cement concrete members and brick work, including fixing mesh in position by necessary drilling in concrete/ B.B masonry, etc. complete.	402.00	sqm			
26	6 mm cement plaster 6 mm cement plaster of mix : 1:3 (1 cement : 3 fine sand) including forming key to receive the finishing coat using coarse, clean sand including surface preparation at all levels, heights and location including all scaffolding, curing in concrete surfaces in roof etc. complete.	207.45	sqm			

27	<p>Providing & applying 18 mm thick external plain faced plaster in cement mortar 1:4 using addition of integral water proofing compound 100% virgin polypropylene fibrillated fibres @125 gm/bag of cement as per manufacturer's specifications waterproofing compound of approved make as per the manufacturer's specifications, in two layers (first layer of 12 mm thickness and the second layer of 6 mm thickness) including forming key to receive the finishing coat, on all types of external surfaces using coarse, clean sand including surface preparation, curing both the coats, bends, grooves, drip moulds, at all levels, heights and location including all scaffolding, curing, providing and fixing chicken mesh of 22 gauge, with about 15 cm. width of approved quality at the junction of reinforced cement concrete members and brick work, including fixing mesh in position by necessary drilling in concrete/ B.B masonry, etc. complete.</p>	268.00	sqm				
28	<p>Providing and laying 50 mm thick heavy duty floor finish in panel size with metallic hardener topping of Ironite or equivalent. Under layer of 38 mm thick cement concrete of grade M25 and top layer of 12 mm thick metallic concrete of mix 1:2 (1 cement hardener mix : 2 stone aggregate 6 mm nominal size) by volume with metallic hardening compound of approved quality mixed as per manufacturer's recommendation including cement slurry, side shuttering, rounding off edges and glass strips of 12mm height x 5mm thick in required panels, etc. complete.</p>	516.80	sqm				

29	Providing and fixing 12 mm thick Vitrified tiles of Nitco / Kajaria / Johnson approved quality and shade in flooring and skirting , on a 20 mm thick bedding of 1:3 cement mortar and jointed with white/ coloured cement slurry, cutting of tiles to required size, cleaning, curing, etc. complete. base rate 1000rs/ sqm	185.50	Sqm				
30	Providing and fixing 10 mm thick ceramic glossy finish tiles of Nitco / Kajaria alps blanco/ Johnsonor equivalent approved quality and shade in dado on a 20 mm thick bedding of 1:3 cement mortar and jointed with white/ coloured cement slurry, cutting of tiles to required size, cleaning, curing, etc. complete. base rate 450 rs/ sqm	64.00	Sqm				
31	Providing and laying for flooring, Antiskid vitrified tiles 12 mm thick of Nitco / Kajaria / Johnson approved quality and shade in required position on 20 mm thick 1:4 cement mortar bedding including cement float, filling joints with white/ coloured cement slurry, cutting of tiles to required size, cleaning, curing, finished to line, length and slope as required, etc. complete. base rate 600 rs/ sqm	17.75	Sqm				
32	Providing and fixing 100 mm skirting of specified material on 20 mm thick bedding of 1:4 cement mortar and jointed with white/ matching coloured cement slurry, cutting of tiles to required size, cleaning, curing, etc. complete.		M				
(i)	vitrified tile	140.00					

33	<p>Providing and fixing 15 mm thick Natural stone to window sill on 20 mm thick cement mortar 1:3 including rounded moulding to the the exposed edge, cement float, filling joints with neat white cement slurry, raking and finishing the joints with silicon sealant, curing, rubbing, polishing and cleaning complete at all levels 2nos in steps on all four sides with minimum 50mm overlapping and maximum of 300mm width in combination. base rate Rs 750 per sqm</p>	28.90	Rmt				
34	<p>Providing and fixing polished granite pantry platform 675 mm deep consisting of 20 mm thick black Granite for counter top over 40 mm thick Kadappa stone slab, 25 to 30 mm thick both side polished kadappa verticles and 150 mm high facial patti in polished granite with nosing, 25 mm thick horizontal Kadappa shelves, including making chases in walls and floor and finishing neat with cement mortar 1:2, providing opening in granite and kadappa for Stainless Steel sink and taps and making moulding and edge polishing all complete as directed by Engineer-in -Charge. All exposed edges of Kadappa and Granite to be polished to the satisfaction of the Engineer as per the design (Supply and fixing of Stainless Sink sink shall be paid separately). All joints shall be made water tight in perfect line level and slope as desired. Only plan area shall be measured for payment. Wastage due to dimensional difference pattern and size shall be to the contractor's account. Filling and finishing of joints shall be done with cement</p>	2.10	sqm				

	and colour pigments Base rate of granite 2500 Rs per sqm						
B	Door window and partition works						
35	<p>Providing, Erecting and Fixing Aluminum POWDER COATED windows confirming to IS:1868. Main frame Shall be made out of hollow extruded sections of size 100mm*75mm*14mm gauge and panelled with approved 5.5mm thick or opaque glass. All aluminum sections will be finished with anti corrosive rust proof coating of approved quality and shade all as per IS codes or as directed, fixed with rawl plugs and screws or with fixing clips or with expansion hold fastners including filling the gaps between opening and aluminium frame with silicon sealant or poly-sulphide sealant as directed, necessary filling up of gaps at junctions, at top, bottom and sides with required PVC/ Neoprene felt, etc. Aluminium sections shall be smooth, rust free, straight, mitred and jointed mechanically wherever required including cleat angle, Aluminium snap beading for glazing/ panelling, C P brass/ stainless steel screws, colour glass of st gobain or equivalent all complete as per architectural drawings and the directions of Engineer.</p>	38.25	Sqm				

36	<p>Providing and fixing single skin precoated galvanized iron profile sheet (size, shape and pitch (175-250mm) and depth (20-30mm) of corrugation as approved by Engg.in Charge) 0.5mm (+0.05%) total coated thickness with zinc coating 150gms per sqm as per IS : 277, in 240mpa steel grade, 5-7 microns epoxy primer on both side of the sheet and polyester top coat 15-18 microns. Sheet should have protective guard film of 25 microns minimum to avoid scratches during transportation and should be supplied in suitable length as desired by Engineer in-charge. The sheet shall be fixed using self drilling /self tapping GI coated screws of size (5.5x 55 mm) with EPDM seal, complete upto any pitch in horizontal/ vertical or curved surfaces, excluding the cost of purlins, rafters and trusses and including cutting to size and shape wherever required. Item is including of moulding of edges all around.</p>	292.50	sqm				
37	<p>Providing, fixing loading unloading and transporting electricacally operated rolling steel shutters fabricated from 18 gauge x 3inch (1.10mm to 1.25mm) MS laths of convex corrugation, complete with build up 4 inchx 1 inch slide guides, build up bottom rail with angle iron at bottom and flat iron at top, brackets, door, suspension shaft, housing box at operation arrangement, lock plates, locking arrangement from inside and outside, fixing bolts, push and pull handles, hood, rolling arrangement and 2 coats of approved synthetic enamel paint over a coat of zinc primer complete. Provision of wicket gate</p>	55.00	sqm				

	shall be paid under separate item, in that case area of wicket gate shall be deducted from this item for payment.					
38	Providing and fixing solid core flush door including chowkhat of 1st class TW with TW frame in Single / Double leaf 35 mm thk. up to 950 mm wide Marine type of exterior grade as per detailed drawings, approved marine plywood facing on both sides without glazing and venetians, with core of block board all necessary T.W. lipping of door thickness, C.P., Brass and S.S. ball bearing Hinges minimum 4 nos per leaf, fixtures and fastenings, door handles, door locks and laminate finish to the satisfaction of Architect. Laminate shall be 1mm thick on both sides, in one piece without joints or broken edges of make Signature, Greenlam, Century or equivalent. The hardware except door hinges shall be paid separately.	11.00	Sqm			
39	Providing and fixing powder coated aluminum doors part panelled and part louvered or glass 8mm thick (for all sizes) Main frame shall be made out of Hollow extruded sections of size 100mm x 75mm x 14 gauge. The louvers shall be made of 5.5mm thick wire glass slided inside suitable aluminum 14 gauges channels fixed to main frame by 2 nos. 4 mm aluminum rivets fixed at 45 deg etc. complete.	33.12	Sqm			
40	Providing and fixing translucent FRP sheet of 6mm thickness inclusive of all fastners, nuts, bolts etc and inclusive of labour complete	44.64	sqm			

41	Wind ties of 40x 6mm Extra for providing and fixing wind ties of 40x 6mm flat iron section	560.00	M				
	PLUMBING WORKS						
A	EXTERNAL DRAINAGE						
42	Construction of best quality approved make stoneware gully trap 150 x 100mm with D.I. Grating including embedding trap in cement concrete 1:4:8 and constructing chamber of size 300 x 300mm x 300mm deep inside clear in brick masonry 230mm thick in cement mortar 1:3, 12mm thick water proof cement plaster in cement mortar 1:3, inside finished with floating coat of neat cement and rough finished outside, providing and fixing D.I. frame and hinged cover 300mm (clear opening) weighting not less than 8.0 Kgs. painting with three coats of anti-corrosive black bitumastic paint, all complete as per specifications of the Engineer-in-Charge. (Excluding Excavation).	5	Nos				
B	WATER SUPPLY PIPES AND FITTINGS (DOWN FEED SYSTEM)						
43	Supplying, installing, fixing, jointing, testing and commissioning of approved make Chlorinated Polyvinyl Chloride pipes (CPVC) up to 50mm dia SDR.11, ASTM CTS, and above 50mm dia CPVC schedule 40 ASTM IPS. Fittings up to 50mm dia SDR.11, ASTM CTS and above 50mm dia CPVC CORZON schedule 40 fittings. Joints to be made with CPVC solvent cement up to 50mm dia as per ASTM D-2846 and above 50mm dia primer P-70, and solvent conforming to ASTM F-4931 / 724.pipe to be laid underfloor / fixed on walls of shafts at all levels using proper hanger supports,grip bolts, clamps, scaffolding, etc. all						

	complete as per specification & direction of Engineer-in-Charge.					
43. a)	20mm dia	120	Rmt			
43. b)	25mm dia	80	Rmt			
43. c)	32mm dia.	40	Rmt			
44	Providing and fixing C.S. heavy approved make ball valves screwed type of the following diameters (20 Kg/cm ²)					
(i)	32mm dia.	2	Nos.			
(ii)	25mm dia.	2	Nos.			
B	WATER SUPPLY TRANSMISSION MAIN UPTO O.H.TANK					
45	Supplying, installing, testing & commissioning approved make Heavy quality (Class C') GI pipes with screwed joints using Teflon tapes including fittings conforming to IS1239 PI & II, Malleable Specials such as tees, elbows, checknuts, unions, flanges, nipples, etc. including cutting, threading, fixing in/on walls at all levels, ceiling, underflooretc., as per drawing. The quoted rate shall include for necessary excavation in any type of soil and back filling, scaffolding, chasing the walls, making bore in wallsetc., and making good the chased surfaces and bores in cement mortaretc.					

	painting the pipes with two coats of approved primer and finishing coat all as per specifications, testing the system complete.					
45. a)	40 mm dia	50	Rmt			
46	Providing and fixing G.M. gate valve screwed type with required 300x300mm masonry chamber in brick bat & C.I. cover all complete.					
46. a)	40 mm dia	2	Nos			
46. b)	50 mm dia	2	Nos			
46. c)	65 mm dia	2	Nos			
C	SOIL, WASTE, VENT, ANTISYPHONAGE AND INTERNAL DRAINAGE PIPES & FITTINGS					
47	Supplying, fixing and testing UPVC soil, waste and ventpipes (SWR) conforming to IS 13592 :1990, type B with Cement Solvent joint inclusive of all necessary specials like bends, tees, offsets, door bends, junctions, vent cowls, etc., laid underfloor / fixed on walls at all levels, and in pipe shaftsetc., complete. The quoted rate should include lead and lifting charges to all levels, necessary scaffolding and supports like hanger supports, grip bolts and clampsetc. as per specification & direction of Engineer-in-Charge.					
47. a)	100mm dia.	10	Rmt			
47. b)	150mm dia.	10	Rmt			

48	Providing and fixing UPVC Aquarius Brand heavy class pipe for drains including providing and fixing necessary fittings such as elbows, tees union fittings etc. including cutting holes and pockets chasing in the wall or floors as required and making good the same to original conditions after concealing the pipes where required, lagging the concealed pipes with hessian cloth dipped in hot black bitumen, testing, all complete as per specifications of the following diameters. (for Sink, Drain, and Urinal Drains)					
48. a)	32mm dia.	5	Rmt			
48. b)	50mm dia.	5	Rmt			
49	Providing and fixing C.P. Brass heavy quality gratings (3mm thick) for floor drains including making necessary recessment grouting with neat cement all complete to the satisfaction and direction of the Engineer-in-Charge.					
49. a)	150mm round/square	5	Nos			
50	Providing and fixing cleanouts consisting of Nickel Bronze clean out ring and disc with three SS screw connecting to P.V.C. pipe all complete to the satisfaction and direction of the Engineer-in-Charge.					
50. a)	160mm dia.	2	Nos			
50. b)	110mm dia.	2	Nos			
51	Providing and fixing PVC Pan connectors with or without vent holes straight/bend including providing & jointing with lead caulked joints.	3	Nos			

52	Providing and fixing PVC. heavy approved Nahani Traps with minimum 40mm seal including fixing the same with the solvent cement joints complete to complete to the satisfaction and direction of the Engineer-in-Charge.					
52. a)	Size 100 x 75mm.	10	Nos			
53	Supply, installation, testing commissioning of UPVC "P" Trap in solvent cement joints all complete.					
53. a)	110mm dia.	4	Nos			
D	RAIN WATER PIPES & FITTINGS					
54	Providing and fixing lead sheet flashing sheet of size 300mm x 300mm to suit the following dia pipes/rain water outlet using lead sheets weighing not less than 27.5 Kg.per sq.m.including moulding to proper shape and grade including cutting of R.C.C. roof slab or wall as required and providing and fixing with cement mortar 1:2 with water proof compoundetc. all complete as per specifications and directions of the Engineer-in-Charge.					
54. a)	200mm dia. Pipe	5	Nos			
54. b)	150mm dia. Pipe	5	Nos			
54. c)	100mm dia. Pipe	5	Nos			
E	SANITARY FIXTURES & FITTINGS					
55	Providing and fixing approved off white vitreous china European water closet comprising of the following for complete installation. Base rate Rs 6000 per EWC	3	Sets			
55. a)	European water closet off white floor/wall mounted including PVC 'P' trap with seat cover CP brass					

	hinges, rubber bushes (1 No.) base rate 6000 rs/ unit					
55. b)	6 Ltrs dual type concealed type PVC flush cistern with adjustable flow rate, push button plate, flush pipe & bend all complete. base rate 6000 rs/ unit					
55. c)	15mm dia. CP heavy approved quality 2-way bib tap with wall flanges (1 No.). base rate 2000 rs/ unit					
55. d)	15mm dia. Approved quality health faucet with flexible tube & wall hook (1 No.). as per approved make.					
55. e)	15mm dia. Approved quality angle valve (1 No.) as per approved make.					
55. f)	Total of all with making necessary inlet/outlet connection all complete.					
56	Providing and fixing below counter wash basins of company Hindware or as per approved make Colour : white, comprising of the following for complete installation. Base rate Rs 2000 per WB					
56. a)	Oval shaped below counter type wash basin. (1 No.)					
56. b)	C.I. Bracket suitable for above (1 Pair)					
56. c)	32mm dia. CP waste coupling (1 No.) as per approved make					
56. d)	32mm dia. CP bottle trap with extension piece, CP wall flange complete. (1 Set) as per approved make	3	Sets			
56. e)	15mm dia. CP heavy angle, stop cock with wall flanges (2 Nos) as per approved make					
56. f)	15mm dia. CP heavy inlet connection pipe (2 Nos)					
56. g)	15mm dia. CP pillar tap as per approved make					
56. h)	Total of all with making necessary inlet/outlet connection all complete.					

57	Providing and fixing ultra White Vitreous China half stall wall hung standard urinals Hindware or Parryware New Magnum No. C0575 or equivalent including fixing the same in concealed C.I. brackets. CP spreader, CP dome shaped waste coupling, CP bottle trap with flanges flush pipe making inlet and outlet connections, including automatic urinal flushing system all complete as per the specifications and directions of the Engineer-in-Charge. Base rate Rs 5000 per Urinal	3	Nos				
58	Providing fixing and installing wall mounted Urinal seperations 900 mm deep and 1200 mm high made of granite of suitable thickness as directed and approved by Engineer-in-charge.The job includes supply and provision of all hardware required for installation.	7	Sqm.				
59	Providing and fixing C.P. open type toilet paper holder 200 x 150mm, including fixing the same with C.P. screws complete as per approved make.	3	Nos				
60	2.5 cu.m.multilayered Sintex Water tank approved by EIC.	2	Nos				
61	Providing and fixing 550 mm dia round shaped mirror above wash basin, 8mm thick mirror with 3/4" bevelling all four sides of make Saint Gobain, Modi, AIS, HNG fixed with either mirror screws or SS studs approved make and colour including all material, tools, tackles etc complete. area of finished glass shall be considered for payment.	3	nos				
62	Soak Pit Making soak pit 2.5 m diaeter 3.0 metre deep with 45 x 45 cm dry brick honey comb shaft with bricks and S.W. drain pipe 100 mm diaeter, 1.8 m long complete as per standard design. With common burnt	1	EA				

	clay F.P.S. (non modular) bricks of class designation 7.5					
63	WIRING:SHORT POINT(GroupA) Wiring for light point/ fan point/ exhaust fan point/ call bell point with 1.5 sq.mm FRLS PVC insulated copper conductor single core cable in surface / recessed medium class PVC conduit, with modular switch, modular plate, suitable GI box and earthing the point with 1.5 sq.mm. FRLS PVC insulated copper conductor single core cable etc as required.- Group A	40	Point			
64	WIRING:SHORT POINT(GroupB) Wiring for light point/ fan point/ exhaust fan point/ call bell point with 1.5 sq.mm FRLS PVC insulated copper conductor single core cable in surface / recessed medium class PVC conduit, with modular switch, modular plate, suitable GI box and earthing the point with 1.5 sq.mm. FRLS PVC insulated copper conductor single core cable etc as required.-Group B	60	Point			
65	WIRING:SHORT POINT(GroupC) Wiring for light point/ fan point/ exhaust fan point/ call bell point with 1.5 sq.mm FRLS PVC insulated copper conductor single core cable in surface / recessed medium class PVC conduit, with modular switch, modular plate, suitable GI box and earthing the point with 1.5 sq.mm. FRLS PVC insulated copper conductor single core cable etc as required.-Group C	20	Point			
66	WIRING:(THREE LIGHT POINTS) Wiring for light point /fanpoint/exhaust fan/call bell point with 1.5 Sq mm PVC insulated copper conductor wires in recessed/surface PVC conduite,with modular switch,modular plate,suitable G.I box and earthing the point with 1.5 sq mm copper conductor wire etc as required. (Excluding of Ckt wiring from D.B to switch boards)Single light point controlled by a 6Amps modular type switch.(e) Three light points controlled by a 6Amps modular type switch.	10	EA			
67	Cu conductor-3X 1.5 Sqmm Supplying and drawing following sizes of FRLS PVC insulated copper conductor, single core cable in the existing surface/	350	M			

TP CENTRAL ODISHA DISTRIBUTION LIMITED
(A Tata Power & Odisha Govt. joint venture)
2nd Floor, IDCO Tower, Janpath Bhubaneshwar, Odisha 751022

NIT No.: TPCODL/P&S/1000000160/2021-22

	recessed steel / PVC conduit as required. 3 X 1.5 Sqmm						
68	Cu conductor-3X 2.5 Sqmm Supplying and drawing following sizes of FRLS PVC insulated copper conductor, single core cable in the existing surface/ recessed steel / PVC conduit as required. 3X 2.5 Sqmm	550	M				
69	Cu conductor-3X 4 Sqmm Supplying and drawing following sizes of FRLS PVC insulated copper conductor, single core cable in the existing surface/ recessed steel / PVC conduit as required. 3X 4 Sqmm	600	M				
70	Cu conductor-3X6 Sqmm Supplying and drawing following sizes of FRLS PVC insulated copper conductor, single core cable in the existing surface/ recessed steel / PVC conduit as required. 3X 6 Sqmm	400	M				
71	WIRING 4x10+2x10 sq mm WIRING 4x10+2x10 sq mm Supply and drawing of following sizes of PVC insulated stranded copper conductor wires of 1100 Volts grade in existing conduit, pipe including connection/termination etc as required.(e) 4x10+2x10 sq mm	120	M				
72	WIRING For 4X16 +2X6 Sqmm Wiring for circuit/ submain wiring alongwith earth wire with the following sizes of FRLS PVC insulated copper conductor, single core cable in surface/ recessed medium class PVC conduit as required. 4 X 16 sq. mm + 2 X 6 sq. mm earth wire	70	M				
73	PVC CONDUIT: (25 mm) Supplying and fixing of following sizes of medium class PVC conduit along with accessories in surface/recess including cutting the wall and making good the same in case of recessed conduit as required. 25 mm	80	M				
74	PVC CONDUIT: (32 mm) Supplying and fixing of following sizes of medium class PVC conduit along with accessories in surface/recess including cutting the wall and making good the same in case of recessed conduit as required. 32 mm	100	M				

TP CENTRAL ODISHA DISTRIBUTION LIMITED
(A Tata Power & Odisha Govt. joint venture)
2nd Floor, IDCO Tower, Janpath Bhubaneshwar, Odisha 751022

NIT No.: TPCODL/P&S/1000000160/2021-22

75	S.P 5/6 amps, one way modular switch Supplying and fixing following modular switch/ socket on the existing modular plate & switch box including connections but excluding modular plate etc. as required. 5/6 amps switch	35	EA				
76	S.P 15/16 amps, one way modular switch Supplying and fixing following modular switch/ socket on the existing modular plate & switch box including connections but excluding modular plate etc. as required. 15/16 amp switch	20	EA				
77	3 pin 5/6 amps, modular socket outlet Supplying and fixing following modular switch/ socket on the existing modular plate & switch box including connections but excluding modular plate etc. as required. 3 pin 5/6 amp socket outlet	35	EA				
78	6 pin 15/16 amps, modular socket outlet Supplying and fixing following modular switch/ socket on the existing modular plate & switch box including connections but excluding modular plate etc. as required. 6 pin 15/16 amp socket outlet	20	EA				
79	Modular base & cover plate 1-2 Module Supplying and fixing following Modular base & cover plate on existing modular metal boxes etc. as required. 1 -2 Module	60	EA				
80	SWITCH ,SOCKETS MK MAKE(6/16A) Supply and fixing of 6/16 Amp switch, sockets of MK make modular type in PVC/GI box complete in all respects with testing & commissioning.	80	EA				
81	FAN REGULATOR Supplying and fixing two module stepped type electronic fan regulator on the existing modular plate switch box including connections but excluding modular plate etc. as required	15	EA				
82	INDUSTRIAL SOCKET OUTLETS (25/32A DPMCB) Supply, installation, testing & commissioning of industrial type plug and socket outlet with SP/TPN MCB (10 KA motor duty) mounted on a sheet steel enclosure including termination, earthing etc as required . (b) Supply and fixing of 25/32 Amp DP MCB (C series) of approved make in MS encloser	15	EA				

TP CENTRAL ODISHA DISTRIBUTION LIMITED
 (A Tata Power & Odisha Govt. joint venture)
 2nd Floor, IDCO Tower, Janpath Bhubaneshwar, Odisha 751022

NIT No.: TPCODL/P&S/1000000160/2021-22

83	Earthing with copper earth plate Earthing with copper earth plate 600 mm X 600 mm X 3 mm thick including accessories, and providing masonry enclosure with cover plate having locking arrangement and watering pipe of 2.7 metre long etc. with charcoal/ coke and salt as required.	6	ST				
84	G.I. earth strip Providing and fixing 25 mm X 5 mm G.I. strip on surface or in recess for connections etc. as required.	70	M				
85	1x 18 Watt LED wall light Supply, storing, fixing, assembling, testing and commissioning of following light fixtures (Recessed/ surface/ceiling/Wall mounted) and fans complete with down rods, chain hangers, lamps, power factor improvement capacitors, ballasts etc and all necessary accessories complete as required. b) 1x 18 Watt LED wall light model type 31081 4 feet long Fixture of philips surface mounted type ,	60	EA				
86	Exhaust fan with louvers and bird-305mm Supplying and fixing of exhaust fan with louvers and bird screen of PVC body in existing opening with 900 rpm (Approved make) b) 305 mm dia	2	EA				
87	Providing and Fixing fan hook Providing and fixing of Fan Hook in existing Slab including cutting cement concrete and making good the same.	15	EA				
88	25 mm Dia PVC flexible conduites Supply and laying of 25 mm Dia PVC flexible conduits complete with dressing and fixing etc,	200	M				
89	LED Flood Light Supply, storing, fixing, assembling, testing and commissioning of following light fixtures (Recessed/ surface/ceiling/Wall mounted) and fans complete with down rods, chain hangers, lamps, power factor improvement capacitors, ballasts etc and all necessary accessories complete as required. b) 1x 120 Watt LED Flood light	8					

90	Electrical Panel Supplying and fixing following prewired Electrical Panel of steel sheet on surface/ recess complete with loose wire box, terminal connectors for all incoming and outgoing circuits, duly prewired with suitable size FRLS PVC insulated copper conductor up to terminal blocks, tinned copper bus bar, neutral link, EArth bar, din bar, detachable gland plate, interconnections, powder painted including EArthing etc. as required.(with MCB/ Isolator)					
		1				
	Total					

NOTE:

- i) The overall period of the rate contract shall be for a period of 1 year and prices shall be firm till the validity of contract. Release order shall be issued as per requirement of TPCODL.
- ii) The bids will be evaluated commercially on the Overall BOQ (inclusive all) lowest cost.
- iii) The bidders are advised to quote prices strictly in the above format. Failing to do so, bids are liable for rejection.
- iv) The bidder must fill each and every column of the above format. Mentioning “extra/inclusive” in any of the column may lead for rejection of the price bid.
- v) No cutting/ overwriting in the prices is permissible.
- vi) Quantities mentioned above is for evaluation purpose only and is not guaranteed. Quantities may change as per actual requirements.
- vii) Make of materials will be as per Annexure II enclosed.
- viii) GA Layout and Foundation layout drawings are enclosed.



TP CENTRAL ODISHA DISTRIBUTION LIMITED
(A Tata Power & Odisha Govt. joint venture)
2nd Floor, IDCO Tower, Janpath Bhubaneswar, Odisha 751022

NIT No.: TPCODL/P&S/1000000160/2021-22

ANNEXURE III

Schedule of Deviations

*Bidders are advised to refrain from taking any deviations on this TENDER. Still in case of any deviations, all such deviations from this tender document shall be set out by the Bidders, Clause by Clause in this schedule and submit the same as a part of the **Technical Bid**.*

Unless specifically mentioned in this schedule, the tender shall be deemed to confirm the TPCODL's specifications:

S. No.	Clause No.	Tender Clause Details	Details of deviation with justifications

By signing this document we hereby withdraw all the deviations whatsoever taken anywhere in this bid document and comply to all the terms and conditions, technical specifications, scope of work etc. as mentioned in the standard document except those as mentioned above.

Seal of the Bidder:

Signature:

Name:



TP CENTRAL ODISHA DISTRIBUTION LIMITED
(A Tata Power & Odisha Govt. joint venture)
2nd Floor, IDCO Tower, Janpath Bhubaneswar, Odisha 751022

NIT No.: TPCODL/P&S/1000000160/2021-22

ANNEXURE IV

Schedule of Commercial Specifications

(The bidders shall mandatorily fill in this schedule and enclose it with the offer Part I: Technical Bid. In the absence of all these details, the offer may not be acceptable.)

S. No.	Particulars	Remarks
1.	Prices firm or subject to variation (If variable indicate the price variation clause with the ceiling if applicable)	Firm / Variable
1a.	If variable price variation on clause given	Yes / No
1b.	Ceiling	----- %
1c.	Inclusive of GST	Yes / No (If Yes, indicate % rate)
1d.	Inclusive of transit insurance	Yes / No
2.	Delivery	Weeks / months
3.	Guarantee clause acceptable	Yes / No
4.	Terms of payment acceptable	Yes / No
5.	Performance Bank Guarantee acceptable	Yes / No
6.	Liquidated damages clause acceptable	Yes / No
7.	Validity (180 days) (From the date of opening of bid)	Yes / No
8.	Inspection during stage of manufacture	Yes / No
9.	Rebate for increased quantity	Yes / No (If Yes, indicate value)
10.	Change in price for reduced quantity	Yes / No (If Yes, indicate value)
11.	Covered under Small Scale and Ancillary Industrial Undertaking Act 1992	Yes / No (If Yes, indicate, SSI Reg'n No.)

Seal of the Bidder:

Signature:

Name:



TP CENTRAL ODISHA DISTRIBUTION LIMITED
(A Tata Power & Odisha Govt. joint venture)
2nd Floor, IDCO Tower, Janpath Bhubaneswar, Odisha 751022

NIT No.: TPCODL/P&S/1000000160/2021-22

ANNEXURE V

Checklist of all the documents to be submitted with the Bid

Bidder has to mandatorily fill in the checklist mentioned below:

S. No.	Documents attached	Yes / No / Not Applicable
1	EMD of required value	
2	Tender Fee as mentioned in this tender	
3	Signed copy of this tender as an unconditional acceptance	
5	Duly filled schedule of commercial specifications (Annexure IV)	
6	Sheet of commercial/technical deviation if any (Annexure III)	
7	Balance sheet for the last completed three financial years; mandatorily enclosing Profit & loss account statement	
8	Acknowledgement for Testing facilities if available (duly mentioned on bidder letter head)	
9	List of Machine/tools with updated calibration certificates if applicable	
10	Details of order copy (duly mentioned on bidder letter head)	
11	Order copies as a proof of quantity executed	
12	Details of Type Tests if applicable (duly mentioned on bidder letter head)	
13	All the relevant Type test certificates as per relevant IS/IEC (CPRI/ERDA/other certified agency) if applicable	
14	Project/supply Completion certificates	
15	Performance certificates	
16	Client Testimonial/Performance Certificates	
17	Credit rating/solvency certificate	
18	Undertaking regarding non blacklisting (On company letter head)	
19	List of trained/untrained Manpower	

Seal of the Bidder:

Signature:

Name



TP CENTRAL ODISHA DISTRIBUTION LIMITED
(A Tata Power & Odisha Govt. joint venture)
2nd Floor, IDCO Tower, Janpath Bhubaneshwar, Odisha 751022

NIT No.: TPCODL/P&S/1000000160/2021-22

ANNEXURE VI

ACCEPTANCE FORM FOR PARTICIPATION IN REVERSE AUCTION EVENT

(To be signed and stamped by the bidder)

In a bid to make our entire procurement process more fair and transparent, TPCODL intends to use the reverse auctions as an integral part of the entire tendering process. All the bidders who are found as technically qualified based on the tender requirements shall be eligible to participate in the reverse auction event.

The following terms and conditions are deemed as accepted by the bidder on participation in the bid event:

1. TPCODL shall provide the user id and password to the authorized representative of the bidder. *(Authorization Letter in lieu of the same shall be submitted along with the signed and stamped Acceptance Form).*
2. TPCODL will make every effort to make the bid process transparent. However, the award decision by TPCODL would be final and binding on the supplier.
3. The bidder agrees to non-disclosure of trade information regarding the purchase, identity of TPCODL, bid process, bid technology, bid documentation and bid details.
4. The bidder is advised to understand the auto bid process to safeguard themselves against any possibility of non-participation in the auction event.
5. In case of bidding through Internet medium, bidders are further advised to ensure availability of the entire infrastructure as required at their end to participate in the auction event. Inability to bid due to telephone line glitch, internet response issues, software or hardware hangs, power failure or any other reason shall not be the responsibility of TPCODL.
6. In case of intranet medium, TPCODL shall provide the infrastructure to bidders. Further, TPCODL has sole discretion to extend or restart the auction event in case of any glitches in infrastructure observed which has restricted the bidders to submit the bids to ensure fair & transparent competitive bidding. In case of an auction event is restarted, the best bid as already available in the system shall become the start price for the new auction.
7. In case the bidder fails to participate in the auction event due any reason whatsoever, it shall be presumed that the bidder has no further discounts to offer and the initial bid as submitted by the bidder as a part of the tender shall be considered as the bidder's final no regret offer. Any offline price bids received from a bidder in lieu of non-participation in the auction event shall be out-rightly rejected by TPCODL.
8. The bidder shall be prepared with competitive price quotes on the day of the bidding event.
9. The prices as quoted by the bidder during the auction event shall be inclusive of all the applicable taxes, duties and levies and shall be FOR at TPCODL site.
10. The prices submitted by a bidder during the auction event shall be binding on the bidder.
11. No requests for time extension of auction event shall be considered by TPCODL.
12. The original price bids of the bidders shall be reduced on pro-rata basis against each line item based on the final all-inclusive prices offered during conclusion of the auction event for arriving at Contract amount.



ANNEXURE II
Approved Make of Materials

Civil, Sanitary Items		
S.No	Material Description	Make
1	Cement (OPC-43 grade / PPC)	Ultratech/ Birla Uttam/ Binani/ Gujrat Ambuja/ ACC / JK Super/ Lafarge NOTE: OPC cement should be used for qty. of cement more than 100 bags at single location.
2	White Cement	Birla/ JK
3	Structural Steel	TATA/ SAIL/ RINL/ IISCO/Kamdhenу/ SCAN/VIZAG NOTE: For Locations where required quantity is more than 10 tonnes at single location and can be brought in one lot, only TATA/ SAIL/ RINL/ IISCO make is to be used.
4	reinforcement steel	Tisco/SAIL/RNIL/IISCO/SCAN/Kamdhenу/VIZAG NOTE: For Locations where required quantity is more than 10 tonnes at single location and can be brought in one lot, only Tisco/SAIL/RINL/IISCO make is to be used.
5	Acid Resistant Tiles	Corromandel, Palicon
6	Floatglass/ Mirror	Modi guard/ Saint Gobain
7	Plastic paint / Apex paint / Enamel Paint/ Primer	Premium quality of Asian/ Berger/ Nerolac/ Dulux
8	Premium acylic smooth paint / Cement Paint / Primer	Snowcem India / Acrocem / Asian / Nerolac
9	Interlocking Tiles	KK / ACME / Dalal / HPI / Recycled
10	Aluminium	Hindalco / Jindal / Mahabir
11	PVC Water Tank (white 3 layer)	Sintex / Sheetal
12	Wash Basin, IWC, EWC etc.	Parryware / Hindware / Somany
13	Kitchen Sink	Neelkanth
14	PVC Pipes and Fittings	Supreme, Prakash
15	CI Soil Pipes / Waste / Rainwater Pipes	S.I.F, R.I.F
16	CP Brass Bib Cock, Stop Cock etc. (Base model)	Parko, Chilli, Hindware Jaguar (For Distt. Offices and other major buildings like Corporate, Scada, KPM, Cenpeid)
17	GI Pipe	Jindal Hisar
18	GI Fittings	Unik
19	U-PVC/C-PVC pipes and fittings	Astral



20	Laminates	Formica, Greenlam, Merino, Sunmica
21	Flush doors	Duro, National, Kitply
22	Board / Ply	National, Kitply, Durian, Greenlam, Century
23	MDF Board - Exterior / Interior Grade	Nuwud, Duratuff, Bajaj Echotech, Action Tesa
24	Particle Board	Bajaj, Action tesa, Novapan
25	Door Closer / Floor Spring	Everite , Doorking, Dorset
		(Ozone, Dorma) (For Distt. Offices and other Major buildings like Corporate, Scada, KPM, Cenpeid)
26	Door Locks and Handles	Godrej , Hettich, Dorset
27	Adhesive	Fevicol, Vamicol
28	Melamine Polish	Asian Paints, MRF, Touchwood, Wemblay
29	Fire Retardent Paint (For all frame works)	Viper FR.881 or Approved Equivalent
30	Textured Paint	Unitex, Dulux, Asian
31	Wood for Framing	Jammu Kail, Marandi, African Hard Wood
32	Veneered Ply	United Veneers, Donear, Duro, Greenlam
33	Glazed / Vitrified Tiles	Kajaria, Somany, Marbonite
34	PTMT Fittings	Prayag India
35	Exhaust Fan	Crompton Greaves, Bajaj
36	Monoblock Pump Sets	Kirloskar, Crompton Greaves
37	Submersible Pump	KSB, Kirloskar, Crompton
38	Brass Bib Cock / Stop Cock	Benson, Pace
39	Brass Ferrule, Gunmetal Valves	DRP
40	Starter for Submersible	L&T or compatible equivalent make
41	GI corrugated Sheets	Jindal, Tisco, SAIL
42	AC Corrugated Sheet	Everest,Charminar
43	Profile sheet	Jindal, TATA, SAIL, Essar, JSW
	Epoxy paint	Pidilite, Asian
Electrical items		
S.No	Material Description	Make
1	M.S. Conduit Pipe (ISI Marked-ERW)	BEC / SENCO(CALCUTTA) /AKG
2	M.S. Conduit Accessories	SHARMA/RAMA/PEI/AKG
3. a)	PVC Insulated Copper Stranded Conductor 1.1 KV Grade Cable	NATIONAL / SKYLINE / FINOLEX / BATRA-HENALY / RR CABLES
b)	PVC Insulated PVC Sheathed Aluminium /Copper Conductor armoured L.T Cable (1.1 KV)	GLOSTER / UNIVERSAL / ICC / INCAB / POLYCAB / HAVELLS

TPCODL

4	Moulded Plate Switch Socket with Switch Boxes & accessories / As per Item : Telephone/Music / Sockets	MK / HAVELLS / North West
5	Lugs/Ferrules	DOWELLS/JAINSON
6	Brass Compression Gland (Heavy Duty)	COMMEX/GRIPWELL
7	MCCB Thermal Magnetic O/C,S/C, E/F (Variable type)	SIEMENS / L&T / ABB /Schneider
8	RCCB / MCB (10 KA)	HAGER / MDS (Legrand) / MERLIN GERIN
9	Distributions Board (Double Door & Metal Clad Socket Outlet)	HAGER / MDS (Legrand) / MERLIN GERIN
10	Telephone Cable	DELTON / NATIONAL / SKYLINE / FINOLEX / HAVELLS
11	Telephone Tag Block with Boxes	KRONE/POUYET
12	Cable Trays	BHARATI / SLOTCO / STEEL WAYS / RICO STEEL
13	Selector Switch	L&T / SIEMENS / BCH / SALZER
14	L.T. Switch by M.V. Switch Boards (Powder Coated)	TRICOLITE / ELECTRO CONTROL SYSTEM / MADHU ELECTRICAL./ ACE Electricals / KMG ATOZ (NOIDA)/RISHA control
15	PVC Conduit (ISI)	BEC / POLYPACK / PRECISION / AKG
16	Measuring Meters	DUCATI / ENERCON / L&T / AE
17	Control Fuses	SIEMENS / GE/ L&T
18	CT'S (Cast Resin)	AEI / KAPPA / PRAGATI / C & S
19	MCCB'S	SIEMENS / L&T / SCHNEIDER / LEGRAND (MDS)
20	GICU. Strip & Earthing Material	BHARATI / INDIANA
21	Ceiling Fan (High Breeze)	CROMPTON / GEC
22	Braket Fan	ALMONARD / CROMPTON / GEC /USHA
23	G.I. Pipe & Accessories (ISI)	TATA/JINDAL/PRAKASH/HISSAR
24	Light Fixture	PHILIPS / DECON / WIPRO, OR APPROVED MAKE/ As per specs if mentioned in BOQ
25	Smoke/Heat Defector	APOLLO/EST (EDWARD), TATA HONEYWELL
26	Fire Alarm Panel with SMF Battery & Battery Charger	MCE / MINIMAX /STYLUSS / AGNI SURAKSHA
27	Response Indicator	APOLLO /EDWARDS /TAT HONEYWELL / AGNI
28	Speaker/ Hooter	PHILIPS/EDWARD/TAT HONEYWELL / AGNI
29	M.S. Conduit ISI	BEC / SENCO
30	Conduit Accessories Heavy Duty (ISI)	SHARMA /PIE EQUIVALENT
31	FRLS PVC Insulated Copper Wire 1.1 KV Grade (ISI)	SKYLINE / NATIONAL / FINOLEX / BATRA HANELY/ RR KABLES
32	Manual Call Station	APOLLO/EDWARD/TAT HONEYWELL / AGNI
33	Exhaust fans	CROMPTON / Newtec / Alsthom
34	Ceiling Rose, Piano type Switches/ Sockets & lamp holders	ANCHOR
35	Changeover Switch / Main switch	L & T / SCHNEIDER / ABB / Siemens
36	Turbo Ventilator	

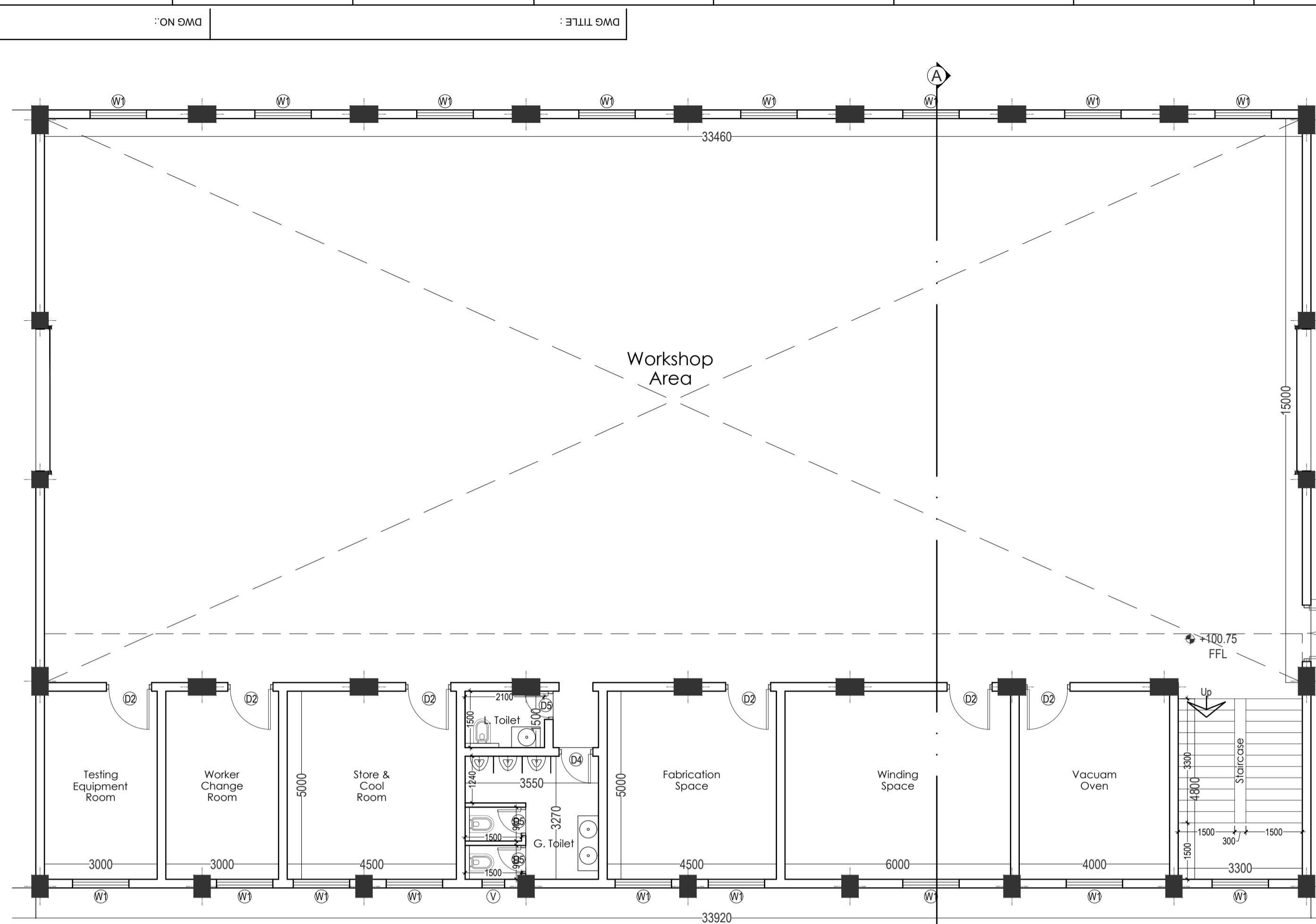

Ground Floor Plan

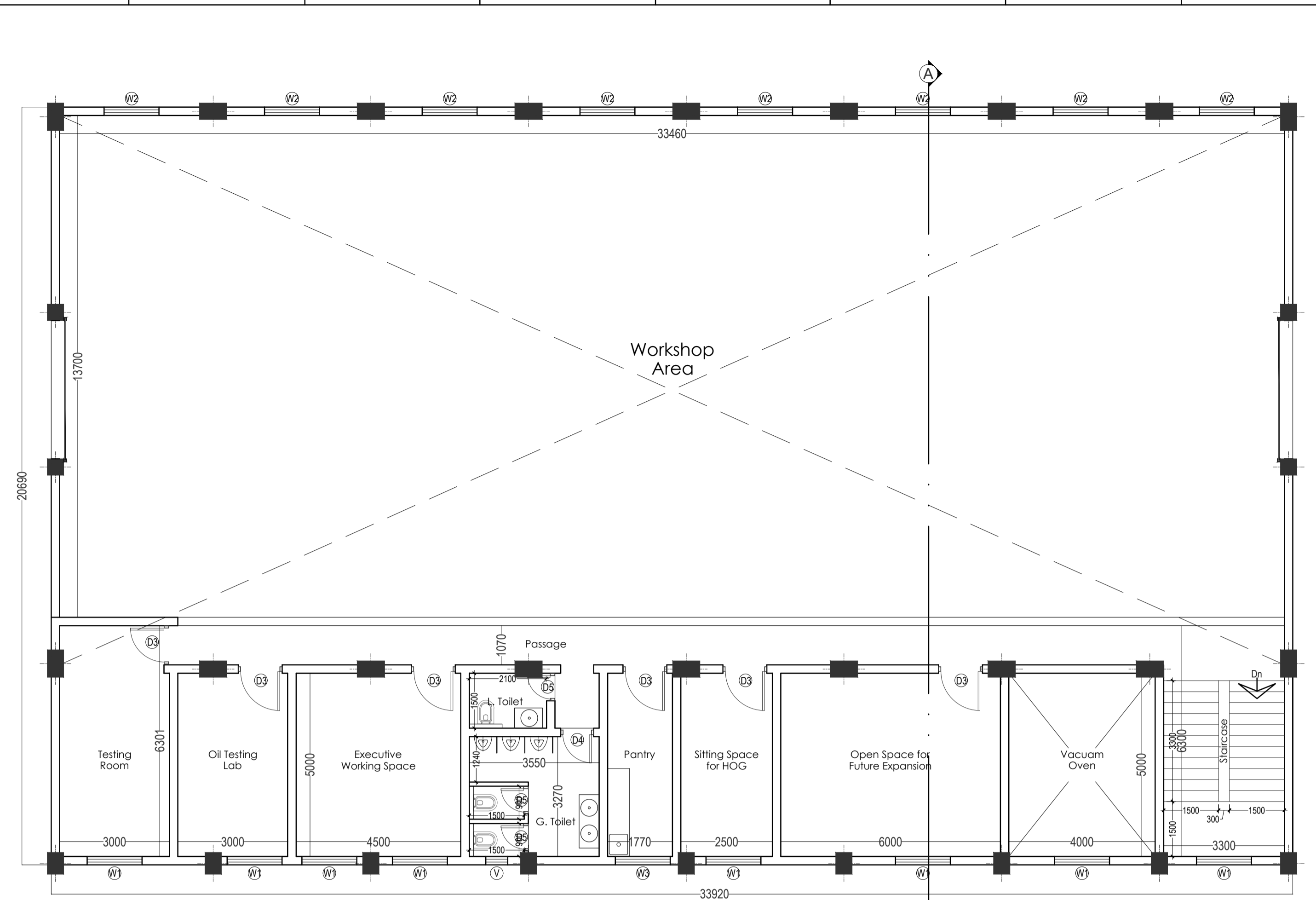

First Floor Plan

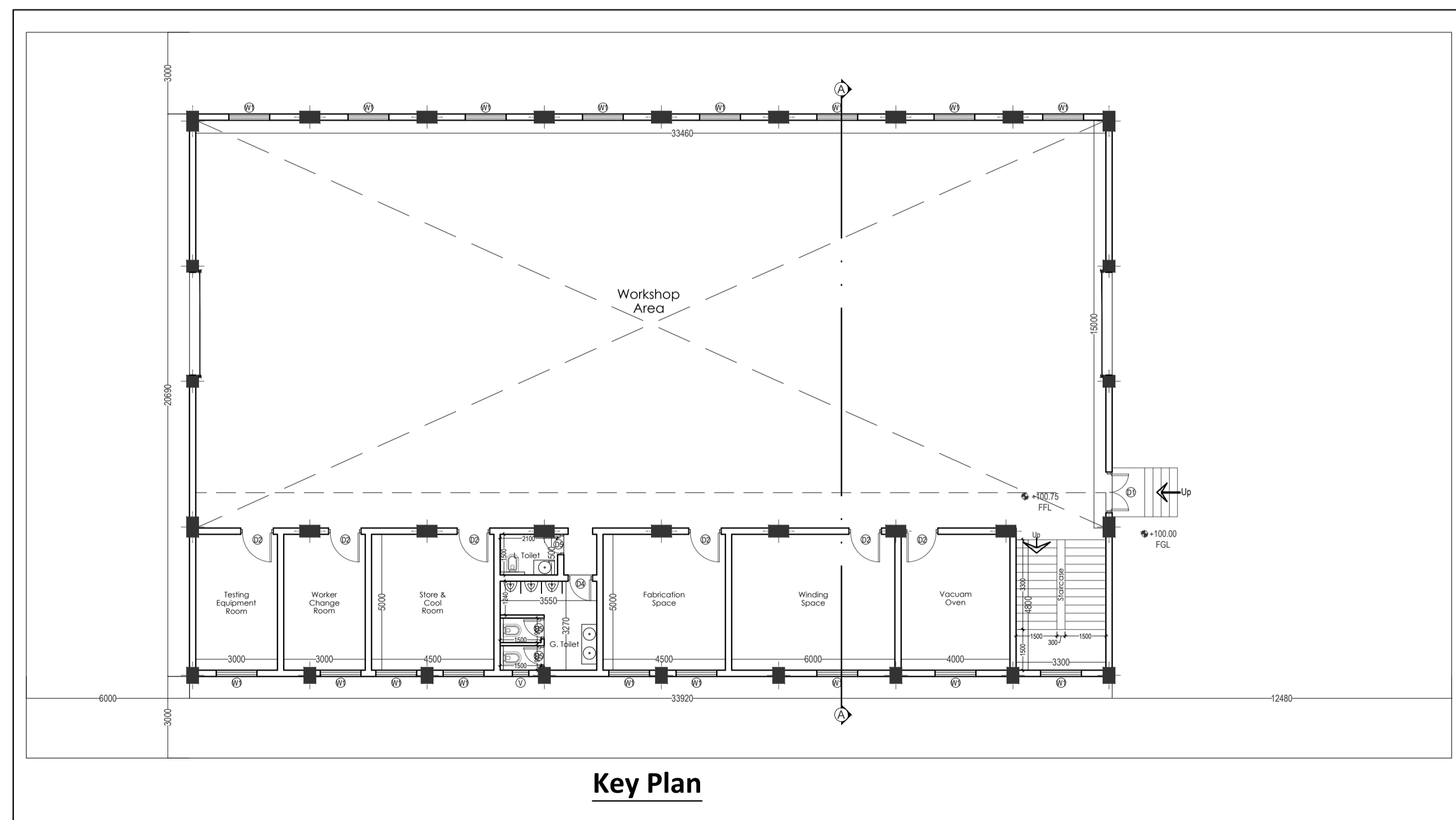

Key Plan

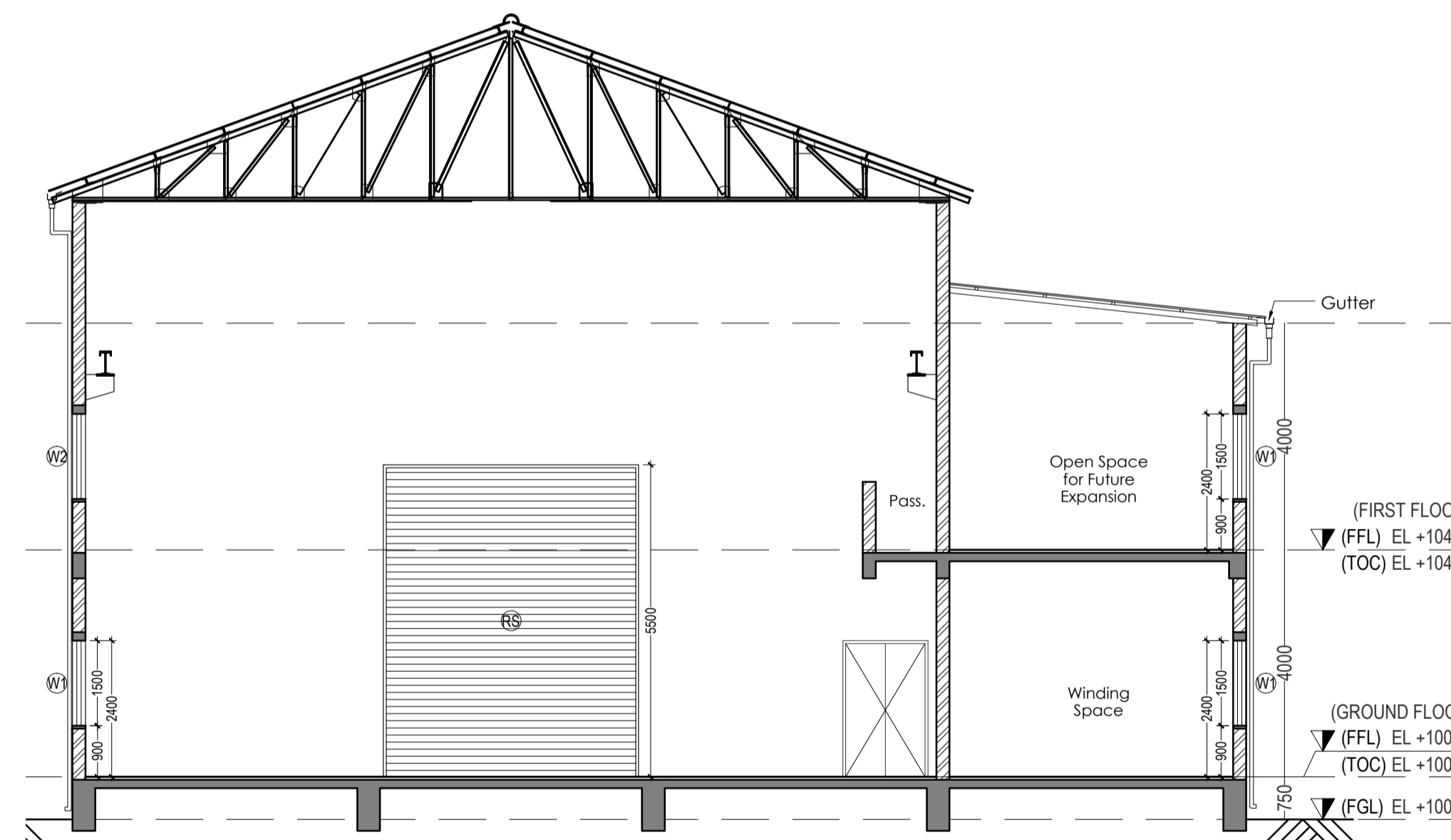

Section A-A

Schedule of Opening				
Schedule of Doors				
S.No.	Door	Size	Description	Sill - Lintel
1	D1	1.50 x 2.40	Double Shutter Fire Door	0.00 - 2.40
2	D2	1.20 x 2.40	Single Shutter Fire Door	0.00 - 2.40
3	D3	1.20 x 2.40	Single Shutter Flush Door With Vision Panel	0.00 - 2.40
4	D4	0.90 x 2.40	Single Shutter Flush Door With Vision Panel	0.00 - 2.40
5	D5	0.75 x 2.10	Single Shutter Pvc Door	0.00 - 2.10
Schedule of Windows				
S.No.	Window	Size	Description	Sill - Lintel
1	W1	1.50 x 1.50	Aluminium Frame Operable Glass Window	0.90 - 2.40
2	W2	1.50 x 1.50	Aluminium Frame Fixed Glass Window	0.90 - 2.40
3	W3	1.50 x 1.20	Aluminium Frame Operable Glass Window	1.20 - 2.40
4	V	0.60 x 0.90	Louvered Ventilator with Exhaust Fan	1.20 - 2.10

TENDER PURPOSE DRAWING

Project: FACELIFT OF FACILITIES AT TPCODL

TITLE: PROPOSED WORKSHOP BUILDING AT CHOWDAR FLOOR PLANS AND SECTION (OPTION -3)

TATA POWER

THE TATA POWER COMPANY LIMITED

SCALE: NTS

DRAWN: AC

CHECKED: MADHURA KORANTAK

REVIEWED: SC

APPROVED: SC

DATE: (REV. 0 ISSUE) 00/00/0000

DATE: (CURRENT REV.) 13/12/2021

REV.: P2

DWG. NO.: CA00170-CHOW-00-A1-001

DEPT	CLEARED			REV	REVISIONS	DRN	CLEARED						APPD	DATE	REV
	SIGNATURE	DATE	REV				CIVIL	ELEC	I & C	MECH	P & L	AUTOM			
CIVIL															
ELEC															
I&C															
MECH															
P & L															
AUTOM															

\\nascent\corporate_engineering\01Proj_Engg\02Engg_ISO\DOCUMENTS\FORMS\Inhouse_Dwg-- (A0 to A4) FORM NO. ENG-FM-37-R1

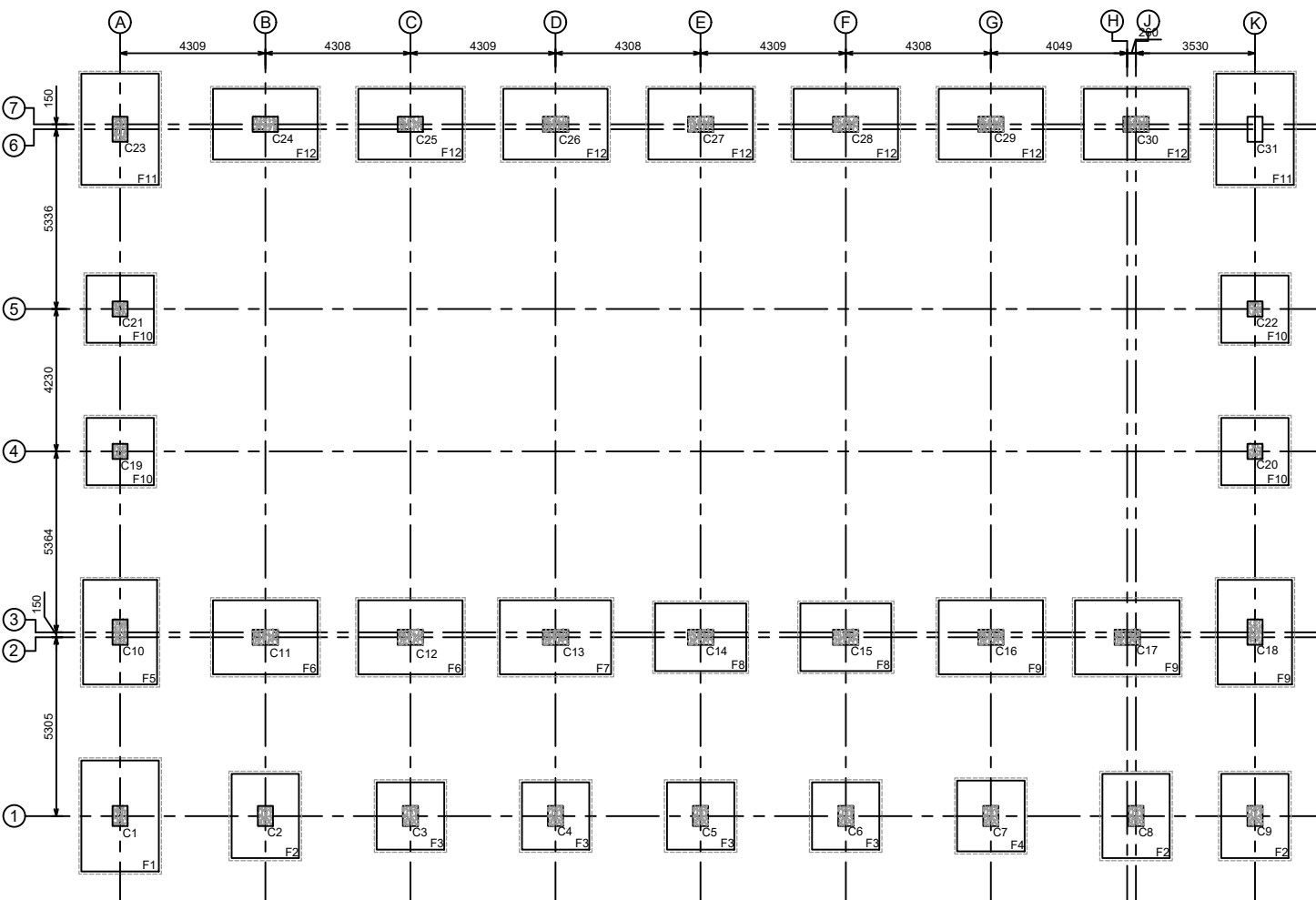

FOUNDATION PLAN
SCALE- 1/25

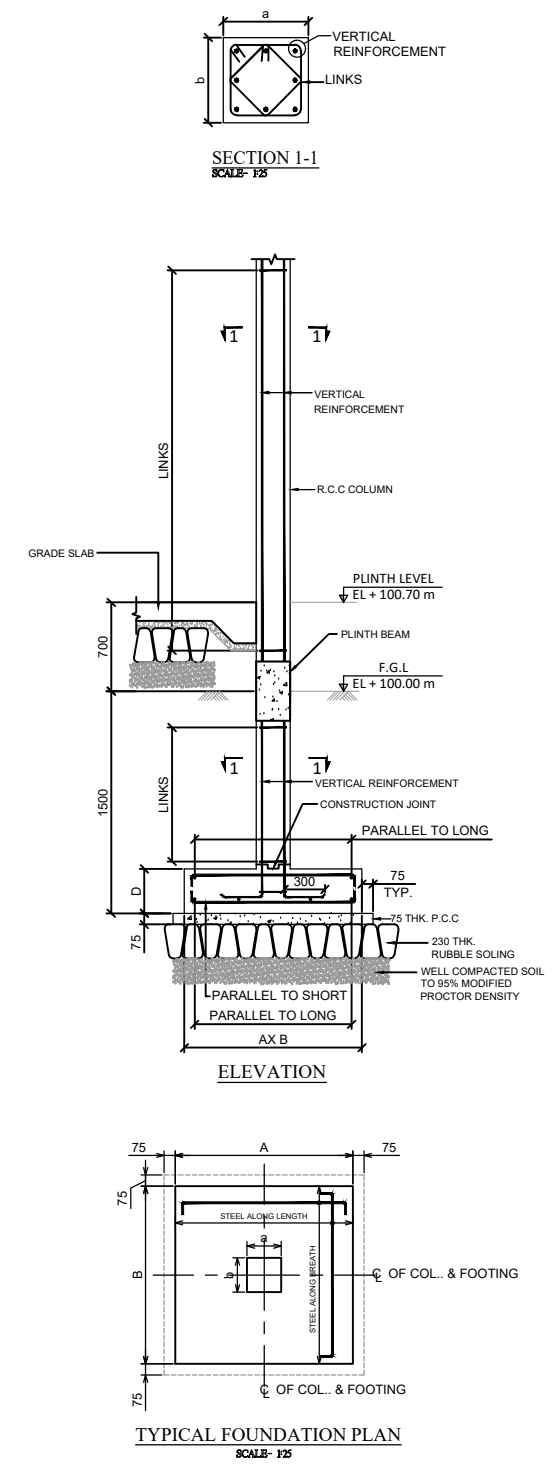

TYPICAL FOUNDATION PLAN
SCALE- 1/25

FOOTING MARK	SCHEDULE OF COLUMN AND FOOTING																																							
	COLUMN MARKS	FOOTING												COLUMN									Plinth to First						First to Second						Second to Roof					
		Size of Footing		Depth of	Reinforcement at Bottom				Reinforcement at TOP				Upto Plinth					Plinth to First				First to Second				Second to Roof														
		A	B		D	Parallel to Long		Parallel to Short		Parallel to Long		Parallel to Short		Size	Vertical Rein.	Links	Size	Vertical Rein.	Links	Size	Vertical Rein.	Links	Size	Vertical Rein.	Links	Size	Vertical Rein.	Links												
			DIA.	C/C	DIA.	C/C	DIA.	C/C	DIA.	C/C	a	b	Nos.	Dia.	Dia.	Spacing	a	b	Nos.	Dia.	Dia.	Spacing	a	b	Nos.	Dia.	Dia.	Spacing	a	b	Nos.	Dia.	Dia.	Spacing						
F1	C1	2300	3300	675	12	125	12	125	10	200	10	200	450	600	16	20	8	300	450	600	16	20	8	300	450	600	16	20	8	300	450	600	16	20	8	300				
F2	C2,C8,C9	2000	2500	525	12	175	12	200	10	200	10	200	450	600	16	20	8	300	450	600	16	20	8	300	450	600	16	20	8	300	450	600	16	20	8	300				
F3	C3,C4,C5,C6	2000	2000	425	12	150	12	150	10	200	10	200	450	600	16	20	8	300	450	600	16	20	8	300	450	600	16	20	8	300	450	600	16	20	8	300				
F4	C7	2000	2100	425	12	150	12	150	10	200	10	200	450	600	16	20	8	300	450	600	16	20	8	300	450	600	16	20	8	300	450	600	16	20	8	300				
F5	C10	2200	3100	625	12	175	12	175	10	200	10	200	450	750	16	20	8	300	450	750	16	20	8	300	450	750	16	20	8	300	450	750	16	20	8	300				
F6	C11,C12	2200	3100	625	12	150	12	125	10	200	10	200	450	750	16	20	8	300	450	750	16	20	8	300	450	750	16	20	8	300	450	750	16	20	8	300				
F7	C13	2200	3300	650	12	150	12	150	10	200	10	200	450	750	16	20	8	300	450	750	16	20	8	300	450	750	16	20	8	300	450	750	16	20	8	300				
F8	C14,C15	2000	2700	525	12	150	12	125	10	200	10	200	450	750	16	20	8	300	450	750	16	20	8	300	450	750	16	20	8	300	450	750	16	20	8	300				
F9	C16,C17,18	2200	3100	650	12	125	12	125	10	200	10	200	450	750	16	20	8	300	450	750	16	20	8	300	450	750	16	20	8	300	450	750	16	20	8	300				
F10	C19,C20,C21,C22	2000	2000	425	12	175	12	175	10	200	10	200	450	450	16	20	8	300	450	450	16	20	8	300	450	450	16	20	8	300	450	450	16	20	8	300				
F11	C23,C31	2300	3300	675	12	125	12	125	10	200	10	200	450	750	16	25	8	300	450	750	16	25	8	300	450	750	16	25	8	300	450	750	16	25	8	300				
F12	C24,C25,C26,C27,C28,C29,C30	2100	3100	650	12	100	12	150	10	200	10	200	450	750	16	20	8	300	450	750	16	20	8	300	450	750	16	20	8	300	450	750	16	20	8	300				

- NOTES :-**
- ALL DIMENSION ARE IN mm. & ALL LEVEL ARE IN MTRS.
 - ⌀ REPRESENTS HIGH YIELD STRENGTH DEFORMED (FE 500) BARS CONFORMING TO IS 1786.
 - CONCRETE GRADE M-25 & PCC M-10 U.N.O.
 - CLEAR COVER TO MAIN BARS.
 - a) FOOTING BOTTOM 75 mm.
 - b) FOOTING TOP & SIDE 50 mm.
 - c) COLUMN 40 mm.
 - d) WALL 40 mm.
 - e) BEAM 25 mm.
 - f) SLAB 15 mm.
 - LAP LENGTH & DEVELOPMENT LENGTH SHALL BE MIN '50 D' .
(D. DIAMETER OF SMALLER BAR) AND 50% OF LAPS SHALL BE STAGGERED.
 - EL: 100 CORRESPONDS TO FGL.
 - BITUMEN COATING SHALL BE APPLIED ON CONCRETE SURFACE IN CONTACT WITH SOIL.

PROJECT : TPCODL

TITLE : FOUNDATION PLAN & R.C.C DETAIL OF WORKSHOP BUILDING AT CHOWDAR

THE TATA POWER COMPANY LIMITED

SCALE : AS NOTED

DRAWN : DATE

CHECKED : OD

REVIEWED : PTM

APPROVED : DATE : (REV.0 ISSUE)

DATE : (CURRENT REV.) 16/12/2021

REV. : P0

DWG. NO. : CA00310-00-C01-C2-048

\\man\corporate\engineering\03\Proj_Eng\02\Eng_50\DCDC\MEM\SY\PC\MS\Inhouse\Draws - (AD to A4)
 FORM NO. ENG-FM-37-R-1

CONTENTS

CLAUSE NO.	DESCRIPTION
1.0	ORGANIZATIONAL VALUES
2.0	ETHICS
3.0	CONTRACT PARAMETERS
3.1	Issue/ Award of Contract
3.2	Contract Commencement Date
3.3	Contract Completion Date
3.4	Contract Period/Time
3.5	Contract Execution Completion Date
3.6	Contract Execution Period/Time
3.7	Contract Price /Value
3.8	Contract Document
3.9	Contract Language
3.10	Reverse Auction
4.0	SCOPE OF WORK
4.1	Technical Evaluation
4.2	Indemnity
4.3	Display of notice boards at work site
4.4	Disposal of waste at site
4.5	Deployment of workforce
4.6	Damage of Properties
4.7	Issuance of material
4.8	Company's right to use works
4.9	Rights of TPCODL to vary the scope work
5.0	PRICES/RATES/TAXES
5.1	For Supply part of Contract
5.2	For Service part of Contract
5.3	Changes in statutory Tax Structure

CONTENTS	
CLAUSE NO.	DESCRIPTION
6.0	TERMS OF PAYMENT
6.1	Pre-Requisites for Payment
6.2	Bills & Invoices
6.3	Payment & Statutory Deductions
6.4	Guidelines for Raising Running/Final Bills
6.5	Quantity Variation
6.6	Full and Final Payment
7.0	MODE OF PAYMENT
8.0	SECURITY CUM PERFORMANCE DEPOSIT
9.0	STATUTORY COMPLIANCE
9.1	Compliance to Various Acts
9.2	SA 8000
9.3	Affirmative Action
9.4	Compliance to Labour Laws
9.5	Compliance to C&D Waste Management Rules & Environment (Protection) Amendment Rules
10.0	QUALITY
10.1	Knowledge of Requirements
10.2	Material/Equipment/Works Quality
10.3	Adherence to Rules & Regulations
10.4	Specifications and Standards
11.0	SAFETY
12.0	INSPECTION/PARTICIPATION
12.1	Right to Carry Out Inspection
12.2	Facilitating Inspection
12.3	Third Party Nomination
12.4	Waiver of Inspections
12.5	Incorrect Inspection Call
13.0	MDCC & DELIVERY OF MATERIALS
13.1	Material Dispatch Clearance Certificate

CONTENTS	
CLAUSE NO.	DESCRIPTION
13.2	Right to Rejection on Receipt
13.3	Consignee
13.4	Submission of Mandatory Documents on delivery
13.5	Dispatch and Delivery Instructions
14.0	GUARANTEE
14.1	Guarantee of Performance
14.2	Guarantee period
14.3	Failure in Guarantee period (GP)
14.4	Cost of repairs on failure in GP
14.5	Guarantee Period for Goods Outsourced
14.6	Latent Defect
14.7	Support beyond the Guarantee Period
15.0	LIQUIDATED DAMAGES
15.1	LD Waiver Request
15.2	Material Recovery
16.0	ASSIGNMENT OR SUBCONTRACTING
17.0	UNLAWFUL ACTIVITIES
18.0	CONFIDENTIALITY
18.1	Documents
18.2	Geographical Data
18.3	Associate's Processes
18.4	Exclusions
18.5	Violation
19	INTELLECTUAL PROPERTY RIGHTS
20	INDEMNITY
21	LIABILITY & LIMITATIONS
21.1	Liability
21.2	Limitation of Liability
22.0	FORCE MAJEURE

Doc. Title	GENERAL CONDITIONS OF CONTRACT - COMPOSITE WORKS	
Rev. No	0	Page 4 of 104

CONTENTS	
CLAUSE NO.	DESCRIPTION
23.0	SUSPENSION OF CONTRACT
23.1	Suspension for Convenience
23.2	Suspension for Breach of Contract Conditions
23.3	Compensation in lieu of Suspension
24.0	TERMINATION OF CONTRACTS
24.1	Termination for default/breach of contract
24.2	Termination for convenience of associate
24.3	Termination for Convenience of TPCODL
25.0	Dispute resolution and Arbitration
25.1	Governing laws and jurisdiction
26.0	ATTRIBUTES OF GCC
26.1	Cancellation
26.2	Severability
26.3	Order of Priority
27.0	INSURANCE
28.0	ERRORS AND OMISSIONS
29.0	TRANSFER OF TITLES
30.0	SUGGESTIONS & FEEDBACK
31.0	CONTACT POINTS
32.0	LIST OF ANNEXURES

Doc. Title	GENERAL CONDITIONS OF CONTRACT - COMPOSITE WORKS	
Rev. No	0	Page 5 of 104

1.0 ORGANIZATIONAL VALUES

The Tata Group has always been a value driven organization. These values continue to direct the Group's growth and businesses. The Six core Tata Values underpinning the way we do business are:

Integrity - We must conduct our business fairly, with honesty and transparency. Everything we do must stand the test of public scrutiny.

Understanding - We must be caring, respectful, compassionate and humanitarian towards our colleagues and customers around the world and always work for the benefit of India.

Excellence - We must constantly strive to achieve the highest possible standards in our day to day work and in the quality of goods and services we provide.

Unity - We must work cohesively with our colleagues across the group and with our customers and partners around the world to build strong relationships based on tolerance, understanding and mutual co-operation.

Responsibility - We must continue to be responsible and sensitive to the countries, communities and environments in which we work, always ensuring that what comes from the people goes back to the people many times over.

Agility - We must work in a speedy and responsive manner and be proactive and innovative in our approach.

2.0 ETHICS

In our effort towards Excellence and in Management of Business Ethics at TPCODL, an Ethics Management Team is constituted.

The main objective of the Ethics Management Team is to:

1. Record, address and allay the issues and concerns on ethics raised by different stakeholders like employees, consumers, vendors, Associates etc. by initiating immediate corrective actions.
2. Ensure proper communication of the ethics policies and guidelines through prominent displays at all offices of TPCODL and through printed declarations in all concerned documents where external stakeholders are involved.
3. Ensure proper framework of policies as preventive measures against any ethics violation recorded by them.
4. Prepare and submit MIS of all issues and concerns, corrective and preventive actions on monthly basis to the top management for their information.

All members of Team TPCODL, Associates and Stakeholders are requested to submit any grievance on ethics violation to Mr. Rajeev Kharyal, Chief Ethics Counselor.

3.0 CONTRACT PARAMETERS

3.1 Issue/Award of Contract

TPCODL awards the contract to the Associate in writing in the form of Purchase order or Rate Contract (RC) hereafter referred as Contract, through in any or all of following modes- physical handover / post / e-mail / web document / fax with all the attachments/enclosures which shall be part of the contract document

Doc. Title	GENERAL CONDITIONS OF CONTRACT - COMPOSITE WORKS	
Rev. No	0	Page 6 of 104

On receipt of the contract, the associate shall return to TPCODL copy of the contract document duly signed by legally authorized representative of associate, within two days of Effective Date of Contract for contracts having contract execution time less than 30 days and within five days for all other contracts.

3.2 Contract Commencement Date

The date of issue/award of contract shall be the Effective Date of Contract or Contract Commencement date.

3.3 Contract Completion Date

The date of expiry of Guarantee Period (detailed in section 12 of this document) shall be deemed as the Contract Completion Date.

3.4 Contract Period/Time

The period from Contract Commencement Date to Contract Completion Date shall be deemed as the Contract Period/Time.

3.5 Contract Execution Completion Date

The stipulated date for completing the execution of all items in the schedule of quantities (Supply, Service and or both as applicable) shall be deemed as the Contract Execution Completion Date.

3.6 Contract Execution Period/Time

The Period from Contract Commencement Date to Contract Execution Completion Date shall be the Contract Execution Period/Time. Timely Completion of Works/Timely Delivery of Materials is the essence of the contract. The period from effective date of contract to the date stipulated for completion of delivery of all items/completion of all the works/services, as per schedule of quantities of the contract is defined as contract execution completion time. The Delivery of Materials /The Completion of Works, as applicable, should be achieved in all respects as per schedules of quantities and all the terms and conditions of the contract, in the contract execution time.

Any revision/amendment in the originally stipulated contract execution time has to be approved by authorized representative of TPCODL.

3.7 Contract Price /Value

The total all inclusive price/value mentioned in the LOI/PO/RC of the contract document is the Contract Price/Value and is based on the quantity, unit rates and prices quoted and awarded and shall be subject to adjustment based on actual quantities supplied/actual measurement of work done and accepted and certified by the authorized representative of the company unless otherwise specified in schedule of quantities or in contract documents.

3.8 Contract Document

The Contract Document shall mean and include but not limited to the following:

- NIT/Tender Enquiry, QR, Instruction to Bidders, Special Condition of Contract (SCC) of tender, GCC, Technical & Commercial Specifications including relevant annexure and attachments).
- Bids & Proposals Received from Associate including relevant annexure/attachments.

Doc. Title	GENERAL CONDITIONS OF CONTRACT - COMPOSITE WORKS	
Rev. No	0	Page 7 of 104

- Letter of Intent (LOI/RC/PO) with agreed deviations from the tender/bid documents.
- All the Inspection and Test reports, Detailed Engineering Drawings.
- Material Dispatch Clearance Certificate (MDCC).
- Minutes of Meeting (MoM)

3.9 Contract Language

All documents, instructions, catalogues, brochures, pamphlets, design data, norms and calculations, drawings, operation, maintenance and safety manuals, reports, labels, on deliveries and any other data shall be in English Language.

The Contract documents and all correspondence between the TPCODL, Third Parties associated with the contract, and the Associate shall be in English language.

However, all signboards required indicating "Danger" and/or security at site and otherwise statutory required shall be in English, Hindi, and local languages.

3.10 Reverse Auction

TPCODL reserves the right to conduct the reverse auction (instead of public opening of price bids) for the products / services being asked for in the tender. The terms and conditions for such reverse auction events shall be as per the Acceptance Form attached in Annexure J. The bidders along with the tender document shall mandatorily submit a duly signed copy of the Acceptance Form as mentioned in the Annexure J as a token of acceptance for the same.

4.0 SCOPE OF WORK

All the activities that are to be undertaken by the Associate to realize the contractual deliverables in completeness form Scope of Work. Following clauses list, but not limited to, major requirements of the scope of work.

The associate shall satisfy himself and undertake fully the technical/commercial requirements of items to be supplied as listed in the Schedule of Quantities together with the tests to be performed /test reports to be furnished before dispatch, arrangement of stage and final inspections during manufacturing as per terms and conditions of contract, technical parameters & delivery terms and conditions including transit insurance to be met in order to fully meet TPCODL's requirements.

Completeness: Any supplies and services which might have not been specifically mentioned in the Contract but are necessary for the scope mentioned in Special Terms & Conditions and/or completeness of the works at the highest possible level, including any royalties, license fees & compensation to be paid, whether incurred by the associates or by a third party for the work covered in the scope, regardless of when incurred, shall be supplied/provided by the associate without any extra cost and within the time schedule for efficient, smooth and satisfactory operation and maintenance of the works at the highest possible level under Indian conditions (but according to international standards for facility of this type), unless expressly excluded from the scope of supplies and services in this Contract.

TPCODL have the right, during the performance of the Contract, to change the scope and/or technical character of the Project and/or of the supplies and services stipulated in the

Doc. Title	GENERAL CONDITIONS OF CONTRACT - COMPOSITE WORKS	
Rev. No	0	Page 8 of 104

Contract by submitting a request in writing to the Associate. The Associate shall, within fifteen days of receipt of such request from the TPCODL, provide Purchaser with a reasonably detailed estimate of the cost of the change outlined in the request.

In the event, TPCODL requests a change, the Contract price and time shall be adjusted upwards or downwards, as the case may be and shall be mutually agreed to. The associate shall not be entitled to any extension of time unless such changes adversely affect the time schedule.

The Associate shall not proceed with the changes as requested till adjustment of contract price and time schedule where so applicable in terms of or otherwise directed by the TPCODL.

4.1 Technical Evaluation

TPCODL reserves the right to assign scores to different parameters including but not limited to the following while evaluating the bids. TPCODL reserves the right to change the parameters and score without prior information to the associates:

S. No.	Evaluation Parameter	Max. Score
A	Bidders already Registered with TPCODL	100
	Quality of the Products & Services	
	a. <u>For Supply Part:</u> No Material Rejections in last 2 years Deduction of 3 marks for each PO/ RO (for same product category) with major rejections in last 2 years. (Major rejection shall be considered when material is taken back by the vendor for rectification and the quantity of rejected material is more than 10%).	12
A.1.	b. <u>For Service Part:</u> No violation of statutory compliances in last 1 year. Deduction of 2 marks for each instance of violation in last 1 year.	12
	c. <u>Safety</u> Deduction of 2 marks for each instance of safety violation in last 1 year. Deduction of 4 marks for each reported Non-Fatal Accident in last 1 year. In case of any reported fatal accident: ZERO MARKS	16
A.2.	Timely Execution of Contracts Total Achieved Score = {30 – 3 x (Avg. %age LD deductions in last 2 years)}	30
A.3.	Legal Issues with TPCODL Zero instances of Arbitration procedures / Court Cases / PBG forfeitures in last 2 years: 30 marks else 'Zero' marks	30
B	Bidders new to TPCODL	100
	Visits <u>For Supply Part:</u> Factory Visit and Evaluation. <u>For Service Part:</u> Client Site Visit where the bidder is providing similar services.	30
B.1.	The visits as above shall be arranged by the bidder. However all costs towards conveyance, lodging, boarding etc. shall be borne by TPCODL. The score assigned by TPCODL based on the above visits shall be final and binding on the bidder.	
	Safety:	20

Doc. Title	GENERAL CONDITIONS OF CONTRACT - COMPOSITE WORKS	
Rev. No	0	Page 9 of 104

S. No.	Evaluation Parameter	Max. Score
	Score achieved against the BA safety Management System questionnaire.	
B.2.	<p>Client Referrals At least 3 nos. Customer References for similar products/ services in last 3 years. All customer references shall be either of the following:</p> <ul style="list-style-type: none"> ▪ Govt. Organizations/ PSUs/ Power Distribution Utilities. ▪ Private Organizations with an annual turnover of \geq 500 cr. PO copies or Completion Certificates are admissible. <p>Each reference: 10 marks</p>	30
B.3.	<p>Blacklisting Information Not blacklisted by any reputed organization / utility in last 2 years: 20 marks else 'Zero' marks.</p>	20

- Bidder shall be considered as technically qualified if they are able to achieve a technical score of >70 marks on the above parameters. 'A' or 'B'.
- The bidder must have the PF and ESI registration. In case it is not there (provided the bidder is not exempted from the PF and ESI), bidder shall not be evaluated on the above parameters and will be considered as disqualified.

4.2 Indemnity

Associates shall undertake to fully indemnify TPCODL (also referred to as the Company in the GCC) against all kinds of liabilities or damages, of whatsoever nature, including compensation arising from any accident to the person or property of those in Associate's employment or to any other person or properties including those of TPCODL, arising due to reasons attributable to any, act, omission or negligence of the Associate the Associates, for the entire period of contract including period of guarantee.

Within 7 days of award of work, the Associates shall submit Indemnity Bond in the format as per Annexure-E to Order Issuing Authority.

Contract having value more than Rs 2 Cr per Annum, Associates shall submit Indemnity Bond on Rs 100/- Non Judicial Stamp Paper in the format as per Annexure- E to Order Issuing Authority.

4.3 Display of Notice Boards at Work Sites

The Associate shall put up display notice board at each project site where the works are in progress indicating the information given below:

- Name of the Project.
- Estimated Cost of Project.
- Date of Commencement.
- Expected date of completion.
- Name of Associate and his telephone number.
- Name of Engineer-in-Charge and his telephone number.

4.4 Disposal of Waste at Site

Significant quantities of waste are generated during the execution of project and an integrated approach for effective handling, storage, transportation and disposal of the same shall be adopted. This would ensure the minimization of environmental and social impact in order to combat the climate change.

Doc. Title	GENERAL CONDITIONS OF CONTRACT - COMPOSITE WORKS	
Rev. No	0	Page 10 of 104

The associates shall follow the below criteria for disposal of waste at site during the execution of project.

- Associate shall ensure that the detailed project plan include the waste management, segregation of all designated waste material (Recyclable/ Non-Recyclable), collecting, storing, disposing and transferring the same to pre-arranged facility/destination in timely and safe manner as per environmental legislations during the execution of project. The project plan shall also include the innovative construction practice to eliminate or minimize waste, protect surface/ground water, control dust and other emissions to air and control noise during the execution of project. The copy of same shall be given to EIC before the commencement of project.
- The purchase policy of BA shall encourage the procurement of material with recycled and minimum packaging of goods during delivery. Associate shall provide the appropriate means for site to site transportation of materials to avoid damage and litter generation.
- Associate shall educate and inform to its project team about the requirement and responsibilities for waste minimization and disposal in general and provide training of practices that support this. Waste management should be treated like a safety program.
- In the event that area of contaminated or biological hazard is identified, Associate shall ensure that plant, equipment, personnel and any activity associated with the work is carried out in consultation with EIC of TPCODL.
- Associate shall ensure that the residents living near the site are kept informed about proposed working schedule and shall informed timings and duration of any abnormal noise full activity that is likely to happen.
- Associate shall ensure the regular maintenance and monitoring of vehicles and equipment for efficient fuel use so that emissions and noise are within acceptable limits to avoid air pollution.

4.5 Deployment of Work Force

Associate shall deploy adequate labour, as considered necessary by TPCODL for execution of the contract including Sundays and Holidays whenever required to do so with no extra cost to TPCODL. However, prior permission shall be taken from the site Engineer to carry out the work beyond normal working hours or on Sundays and Holidays. Female employees shall not be deployed beyond normal working hours/days and no child labour shall ever be deployed. Associate shall depute full time qualified and experienced engineers to supervise the work at site. All such staff shall be maintained from commencement to completion of all works to the entire satisfaction of the Engineer-in-Charge. Associate's employees deployed for the works under this contract will not be considered in Company's employment at any time. Associate shall continue to be responsible for all such employees, their safety, all types of statutory compliances related thereto and in any other manner whatsoever. The company will stand indemnified by the Associate in respect of all the above. At the same time Company upon noticing any breach or default on any statutory compliances, may at their sole discretion, decide to act in a manner as deemed fit at the risks and costs of the Associate.

Doc. Title	GENERAL CONDITIONS OF CONTRACT - COMPOSITE WORKS	
Rev. No	0	Page 11 of 104

TPCODL shall have the right to instruct the Associate to change the Sub- Associates or skilled /unskilled workers in case the conduct, the workmanship or speed of the work is not satisfactory.

Associates shall submit duly signed undertaking regarding engagement of competent staff / employee commensurate to the nature of job to Engineer-in-charge in the format attached as Annexure – H.

4.6 Damages to Properties

The Associates shall take necessary steps to ensure that the equipment and installations of the Company, Third parties, including other utility services like water supply pipelines; open drains telephone cables etc. are not damaged during execution of the works. The Associates shall be responsible for all such damages and shall have to repair/ replace and/or compensate for the entire claims in respect of such damages at its own cost.

4.7 Issuance of Material

The material issued to the Associate shall be in the custody of the Associates who shall be fully responsible for the same. After completion of the works, the Associates will reconcile the material. Any cost of material which is short or damaged/lost will be deducted from Associate bill/ deposits.

4.8 Company's Right To Use Works

If Taking Over Certificate is delayed for any reason, for which TPCODL's decision shall be final and binding upon the Associate, the Company shall be entitled to use the works or portion thereof without affecting Associate's responsibility and liability to complete the balance works as per company's directives from time to time, though Associate shall be afforded reasonable opportunity by the company to enable Associates to complete all balance works required for issuance of 'Taking Over Certificate' by the company.

4.9 Rights of TPCODL to vary the scope work

TPCODL shall have the right, during the performance of the Contract, to change the scope and/or technical character of the Project and/or of the supplies and services stipulated in the Contract by communicating the intent to do so in writing to the Associate. On receipt of such communication the Associate shall, within the time frame specified in the contract shall provide TPCODL with a reasonably detailed estimate of the cost of the change in scope outlined in the TPCODL communication. The change in the Contract price and time shall be revised upwards or downwards, as the case may be, and shall be mutually agreed to. The Associate shall not be entitled to any extension of time unless such changes adversely affect the time schedule.

The Associate shall not proceed with the changes in the scope of work till such time revision of Contract price and time schedule are approved and communicated to the associate by TPCODL.

Any change in the Scope of Work and/or Terms & Conditions of the order shall be intimated by TPCODL through an amendment to the contract. The amendment shall be treated valid only if signed by the authorized signatory of the original contract.

5.0 PRICES/ RATES/ TAXES

5.1 For Supply part of Contract

Doc. Title	GENERAL CONDITIONS OF CONTRACT - COMPOSITE WORKS	
Rev. No	0	Page 12 of 104

Unless specified elsewhere in the contract document, the prices/rates are inclusive of cost of finished product for which MDCC will be issued by TPCODL, packaging and forwarding charges, freight and transit insurance charges covering loading at Associate's works, transportation to TPCODL store/site & unloading & delivery at TPCODL stores/TPCODL site, cost of documentation including all the relevant test certificates and other supportive documents to be furnished.

The Prices/Rates are inclusive of all taxes, levies, cesses and duties, particularly Goods and Services Tax as applicable. All government levy / taxes shall be paid only when the invoice is submitted according to the relevant act.

The prices/rates shall remain firm till actual completion of entire supply of goods/material/equipment as per contract is achieved and shall remain valid till the completion of the contract.

The prices shall remain unchanged irrespective of TPCODL making changes in quantum in all or any of the schedules of items of contract.

5.2 For Service part of Contract

The Prices and Rates are inclusive of cost of materials supplied as per contract terms and for which MDCC is issued by TPCODL and to the extent required for completion of works, cost of service executed as per schedule of quantities, cost of testing as per contract terms, cost of documentations including all relevant test certificates and other supportive documents to be furnished as per contract terms. The rates shall remain firm till actual completion of contract.

The Prices/Rates are inclusive of all taxes, levies, cesses and duties, particularly Goods and Services Tax as applicable. All government levy / taxes shall be paid only when the invoice is submitted according to the relevant act.

The prices shall remain unchanged irrespective of TPCODL making changes in quantum in all or any of the schedules of items of contract.

5.3 Changes in Statutory Tax Structure

If rate of any or all of the statutory taxes and duties applicable to the contract changes, such changes shall be incorporated by default if the changes occur within the contract execution time and shall be applicable if the contract is executed by the Associate within the Contract Execution Time.

For execution of contracts beyond contract execution time, where the delay is not attributable to TPCODL no upward revision in tax /duties shall be considered irrespective of changes in the statutory tax structure either within the contract execution time or beyond. However, in such cases, benefits due to any downward revisions in statutory tax rates shall be passed on to TPCODL.

6.0 TERMS OF PAYMENT

- A. 5% of the Release Order/ Purchase Order price shall be paid as initial interest free advance on fulfillment of the following by the Associate:
 - a) Acceptance of PO/ LOI.
 - b) Submission of advance payment BG of 15% of the Release Order/ Purchase Order price which shall remain valid till the advance is fully adjusted.

Doc. Title	GENERAL CONDITIONS OF CONTRACT - COMPOSITE WORKS	
Rev. No	0	Page 13 of 104

- c) Submission of Contract Performance Bank Guarantee of 5/10% of the RC/ PO price valid till 30 days after taking over of the works.
- B. 10% of the Release Order/ Purchase Order price shall be paid as interest free advance against approval of drawings under Category-1 of major drawings, Quality Plans, Pert Chart, Field Quality Plan, posting of Project Manager and commencement of the first mile stone of the work mutually agreed including C-3 Form, and submission of a true copy of 'Erection All Risk Insurance Policy' taken for the awarded jobs. The drawing list shall be mutually agreed at the time of award of work.
- C. 50% on account payment of the total of item wise cost of material Release Order/ Purchase Order shall be paid against receipt of material at site in good condition and certification by TPCODL along with bills complete in all respects viz. MDCCs etc.
- D. 20% on account payment of the actual executed value shall be paid against mechanical completion of erection on prorata basis against monthly bills and 70% on account of the actual executed value shall be paid against the service line item including composite line item. In case this milestone is not completed beyond 120 days for reasons attributable to TPCODL, the payment corresponding to supply part shall be released subject to submission of BG of equivalent amount by the BA valid for a period of further 12 months. If required, it shall be extended by the BA on request of TPCODL.
- E. 15% payment of the actual executed Release Order/ Purchase Order shall be paid after completion of acceptance test and Taking Over of the complete systems specified in the enquiry, including clearance of Electrical Inspection, compliance of final punch point and after reconciliation & adjustment of payments, if any, towards Quantities of materials issued from purchaser's stock and consumed by the contractor for expeditious completion of the job. In case this milestone is not completed beyond 120 days beyond schedule for reasons attributable to TPCODL, the payment corresponding to supply part shall be released subject to submission of BG of equivalent amount by the BA valid for a period of further 12 months. If required, it shall be extended by the BA on request of TPCODL.

The Contractor shall submit all Operation & Maintenance manuals and "As Built Drawings" etc. and shall also submit Equipment Warranty Bank Guarantee (EWBG) equivalent to 5/10% of actual executed contract price before the release of this last payment and return of CPBG. The validity of EWBG shall be for a period of 15 months from the date of taking over of the works or specified guarantee period in drawing/tender/technical specification documents etc. whichever is later. The associate shall also submit 'No Demand Certificate' at the time of receipt of full and final payment.

6.1 Pre-Requisites for Payment

- Associate should have completed execution of that part of contract, for which payment is sought, to the satisfaction of TPCODL's Engineer-in-Charge responsible for the contract and obtained certification for execution of the work.
- Associate has undertaken joint measurement of the work executed along with TPCODL's Engineer-in-charge

Doc. Title	GENERAL CONDITIONS OF CONTRACT - COMPOSITE WORKS	
Rev. No	0	Page 14 of 104

- Associate's bills/invoices submitted have been certified by Engineer-In-Charge.

6.2 Bills & Invoices

Unless specified otherwise in the special conditions of contract, Associate shall raise not more than one invoice/contract per month for the services rendered in the prescribed Tax Format and the invoice shall be submitted within 15 days of the following month at Bill Inward Receipt Desk (BIRD) located at IDCO Towers, Janpath, Bhubaneswar.

All Bills shall be supported by joint measurement of work done, quality test report and a copy of wage sheet, if applicable (showing proof of having disbursed wages as per applicable law) and a copy of statement substantiating that statutory payments having been affected.

Bills/ invoices shall mention Associate's 'Sales, Service, WCT Tax Registration Number, PAN number as applicable.

Final bill submission after completion of project or execution of job must be within 30 days from the actual date of completion/execution of work awarded.

6.3 Payment & Statutory Deductions

Payment shall be released within 30 days from the submission of the bills. The associate shall submit "No Demand Certificate" in the format as per Annexure-D at the time of receipt of full and final payment. In case any non-compliance to contract conditions comes to TPCODL's notice, TPCODL will be entitled to deduct 30% of estimated wages plus 20% of wages as TPCODL's overheads. Associates would be obliged to provide the copy of monthly wage sheet in any case, failing which no payment shall be made. TPCODL at their sole discretion may deposit the PF etc. with statutory authorities. TPCODL will deduct the amounts of TDS as per statutory requirement under the income tax act and the DVAT Act and certificates (wherever applicable) will be issued to associate accordingly.

In case of non-submission of PAN No TDS @ 20% shall be deducted from all payable amounts for which no TDS certificate shall be issued. TDS once deducted as above shall not be revised in any condition.

6.3.1 Statutory Deductions

TPCODL will deduct the amounts of TDS, TCS as per statutory requirement under the income tax act, the Goods and Services tax act, BOCW Act, or any other applicable tax act and certificates (wherever applicable) will be issued to associate accordingly. For consumption of TPCODL's Water and Electricity by Associate for execution of Contract, Associate shall pay 0.5% & 1.0% respectively of contract value and it shall be deducted from the running bills. The Engineer-in-Charge as stated in the Order shall be responsible for certification of the work executed and the bills. Bills (including original) shall be submitted in triplicate at Bill Inward Receipt Desk (BIRD) located at IDCO Towers, Janpath, Bhubaneswar.

6.4 Guidelines for Raising Running/Final Bills

Contract Value Up to 5 Lakhs	One Final Bill
Contract Value More than 5 lakhs	Monthly Running Bill & One Final Bill

All Bills shall be processed only when all bank Guarantees are in place and before payments of Final Bill Associate have to furnish NDC.

Doc. Title	GENERAL CONDITIONS OF CONTRACT - COMPOSITE WORKS	
Rev. No	0	Page 15 of 104

6.5 Quantity Variation

Payment will be made on the basis of actual quantity of supplies/actual measurement of works accepted by TPCODL and not on the basis of contract quantity.

6.6 Full and Final Payment

Full & Final Payment in all contracts shall be made subject to the associate submitting "No Demand Certificate" in the format as per Annexure-D.

7.0 MODE OF PAYMENT

Payment shall be made through RTGS mode for which Business Associated shall submit the details of Bank Account and other details as per annexure K. Further, for any payments made, TPCODL is not responsible for any consequences/disputes Associate have among the owners channel partners, sub-Associates and all such dispute/concerns shall be settled solely by the Associate.

The quantities of items indicated are estimated and preliminary. However, payments shall be made on the basis of actual quantity of work carried out and measured jointly by the Company and the Associate. Associates shall be responsible to organize joint measurements of works with TPCODL Engineer-in-Charge before raising any bill of work done. In the event Associate fails to do so, TPCODL at their sole discretion, may take measurements of work done and proceed as deemed fit and in such an event Associate's right to lodge any subsequent claim shall stand forfeited.

8.0 SECURITY CUM PERFORMANCE DEPOSIT

Associates shall submit within 15 days from the effective date of issue of PO/RC, Security cum Performance Guarantee (SPBG) in the format as per Annexure B of this document from banks acceptable to TPCODL for:

(a) 5% of the PO value if purchase order value is more than Rs 5 Crores.

(b) 10% of the PO value if purchase order value is less than Rs 5 Crores.

This shall remain valid till the end of the Guarantee Period of contract, plus one month.

(c) 5% of the RC value in case of Rate Contract. This shall remain valid till the Guarantee period plus one month.

- For PO/RC values less than Rs. 5 lacs, Associate may request for deduction of amount equivalent to SPBG value from their first invoice. Such amount shall be withheld by TPCODL while processing the invoice and shall be released after completion of Guarantee Period plus one month.
- For PO/RC values less than Rs. 3 lacs, the clause (8.0) for Security cum Performance Bank Guarantee (SPBG) shall not be applicable.
- In case of RC (Rate Contract) after the expiry of RC validity, Associate shall have to submit SPBG. However, the Associate has the option to re-submit the SPBG as per actual RO (Release Order) value issued against the RC, valid for Guarantee Period plus one month. The Guarantee Period shall be considered as per the last RO issued against the said RC. The original SPBG as submitted against the RC shall be released on submission of the new SPBG to TPCODL. Alternatively, Associate may extend the

Doc. Title	GENERAL CONDITIONS OF CONTRACT - COMPOSITE WORKS	
Rev. No	0	Page 16 of 104

validity of original SPBG only till the requisite period, i.e. Guarantee Period plus one month.

9.0 STATUTORY COMPLIANCE

9.1 Compliance to Various Acts

Associate should ensure adherence to all applicable laws, rules and regulation applicable under this contract from time to time. In case of violation any risk, costs etc shall be in associates account and keep TPCODL indemnified always till completion of contracts.

9.2 Social Accountability

TPCODL expects its Associates to follow guidelines of best practices on the following aspects

1. Child Labour
2. Forced or Compulsory Labour
3. Health & Safety
4. Freedom of Association & Right to Collective Bargaining
5. Discrimination
6. Disciplinary Practices
7. Working Hours
8. Remuneration
9. Management System

9.3 Affirmative Action

TPCODL appreciate and welcome the engagement/employment of persons from SC/ST community or any other deprived section of society by their business associates.

Relaxation in Contract Clauses under Affirmative Action for SC/ ST Business Associates**

TPCODL believes that inclusive growth is the key to sustainable development, and to promote the same Policy on Affirmative Action for Scheduled Caste & Scheduled Tribe Communities has been adopted across the company.

Under the same pre-text, and to promote entrepreneurship among SC/ST community TPCODL has taken initiative by proposing relaxations in contract clauses as per below:

S. No.	Initiative	for SC/ ST BA's	Guideline Document
1	Tender Fees	100% waiver for SC/ST community	All Open Tenders
2	Earnest Money Deposit	50 % relaxation of estimated EMD value	All limited and Open Tenders
3	Performance Bank Guarantee	25% relaxation in PBG for order value above 50 lacs else 50% relaxation	All limited and Open tenders
4	Turnover	25% relaxation in company turnover under qualifying requirement criteria	All Open Tenders

Doc. Title	GENERAL CONDITIONS OF CONTRACT - COMPOSITE WORKS	
Rev. No	0	Page 17 of 104

****Classification of BAs under SC/ST shall be governed under following guidelines:**

- Proprietorship/ Single Ownership Firm: Proprietor of the firm should be from SC/ST community. Governing document shall be duly audited balance Sheet for the last FY bearing the name of proprietor.
- Partnership Firm: Only such firms shall qualify which have SC/ST partners holding equal to or more than 50% of the total ownership pattern of the firm. Governing document shall be Partnership Deed and audited balance sheet/ ITR for last FY.
- Private limited company: Only such firms shall qualify which have SC/ST directors holding equal to or more than 50% of the total ownership pattern of the firm. Governing document shall be Memorandum of Understanding (MoU) and/or Article of Association (AoA).

Certification from SC/ST commission shall be required for deciding upon SC/ST status of a person.

9.4 Compliance to Labour Laws

Bidder needs to ensure compliance to applicable labour laws including timely disbursement of wages. In case wages are not disbursed as per the stipulated timelines, then TPCODL shall pay the wages to BA employees on behalf of BA. Apart from deducting the amount of wages paid, TPCODL shall deduct an additional service charge equivalent to 25% of the wages paid from the payment due to BA.

9.5 Compliance to Construction and Demolition Waste Management Rules & Environment (Protection) Amendment Rules

BA is liable to follow the Construction and Demolition Waste Management Rules- 2016, Environment (Protection) Amendment Rules- 2018 and Guidelines on dust mitigation measures in handling construction material and C&D wastes issued by CPCB.

Following are some main points of above Rules/Guidelines for Construction work, cable laying jobs etc.

1. Barricading to be provided at site to cover complete area.
2. Construction material and waste should be inside the closed area made by using barricading.
3. Water sprinkling/fine spray from nozzles to be done to suppress the dust.
4. The board of Dust mitigation measures shall be displayed at site for public viewing with required details.
5. Loose sand or soil and construction material that causes dust shall be covered.
6. Transport material that are easily wind borne need to be covered by a sheet made of either jute, tarpaulin, plastic or any other effective material.
7. All areas for storing C&D waste/construction material to be demarcated and preferably barricaded particularly those materials that have potential to be dust borne.
8. Grinding and cutting of building materials in open area shall be prohibited.
9. Construction material and waste should be stored only within earmarked area and road side storage of construction material and waste shall be prohibited.
10. No uncovered vehicles carrying construction material and waste shall be permitted.
11. Construction and demolition waste processing and disposal site shall be identified and required dust mitigation measures to be notified at the site.

Doc. Title	GENERAL CONDITIONS OF CONTRACT - COMPOSITE WORKS	
Rev. No	0	Page 18 of 104

10.0 QUALITY

10.1 Knowledge of Requirements

The Associate shall be deemed to have carefully examined and to have knowledge of the equipment, the general and other conditions, specifications, schedules, drawings, etc. forming part of the Contract and also to have satisfied himself as to the nature and character of the work to be executed and the type of the equipment and duties required including wherever necessary of the site conditions and relevant matters and details. Any information thus procured or otherwise obtained from TPCODL/Consultants shall not in any way relieve the Associate from his responsibility and executing the works in accordance with the terms of contract.

10.2 Material/Equipment/Works Quality

The items / works under the scope of the Associate shall be of the best quality and workmanship according to the latest engineering practice and shall be manufactured from materials of best quality considering strength and durability for their best performance and, in any case, in accordance with the specifications set forth in this Contract. All material shall be new. Substitution of specified material or variation from the process of fabrication/construction/manufacture may be permitted but only with the prior written approval of the TPCODL.

10.3 Adherence to Rules & Regulations

The Associate shall procure and/or fabricate/erect all materials and equipment in accordance with all requirements of Central and State enactment, rules and regulations governing such work in India and at site. This shall not be construed as relieving the Associate from complying with any requirement of TPCODL as enumerated in the Contract which may be more rigid than and not contrary to the above mentioned rules, nor providing such construction as may be required by the above mentioned rules and regulations. In case of variance of the Technical Specification from the laws, ordinance, rules and regulations governing the work, the Associate shall immediately notify the same to the TPCODL. It is the sole responsibility of the Associate, however, to determine that such variance exists. Wherever required by rules and regulations, the Associate shall also obtain the statutory authorities' approval for the plant, machinery and equipment to be supplied by the Associate.

10.4 Specifications and Standards

The Associate shall follow all codes and standards referred in the Contract Document. Codes and standards of other may be followed by the Associate with the prior written approval of TPCODL, provided materials, supplies and equipment according to the standard are equal to or better than the corresponding standards specified in the Contract.

Brand names mentioned in the Contract documents are for the purpose of establishing the type and quality of products to be used. The Associate shall not change the brand name and qualities of the bought out items without the prior written approval of the TPCODL. All such products and equipment shall be used or installed in strict accordance with original manufacturer's recommendations, unless otherwise directed by the TPCODL. In any

Doc. Title	GENERAL CONDITIONS OF CONTRACT - COMPOSITE WORKS	
Rev. No	0	Page 19 of 104

circumstances the codes, specimen and standards prescribed by any government agency should not be violated.

11.0 SAFETY

All Associates shall strictly abide by the guidelines provided in TPCODL's Contractor Safety Management System (CSMS) as applicable at all stages during the contract period. Associate shall execute the contracts ensuring the following in and as order of priority:

- Safety of Human Beings.
- Safety of equipment/Assets.
- Timely Completion of Contract.

Safety related requirements as mentioned in our Contractor Safety Management System is attached as annexure L and is an integral part of this GCC.

12.0 INSPECTION/PARTICIPATION

12.1 Right to Carry Out Inspection

TPCODL reserves the right to send its representatives for inspection or participation at various stages of contract execution listed below, applicable as per contract construction.

- During basic design and detail engineering of material/ Equipment carried out by Associate /Outsourced Agencies.
- During manufacturing stages of the product at Associate's/Associate's Outsourced Agency's Plant/Facility.
- During Pre-dispatch Inspection and Testing of finished/manufactured product at Associate's/Associate's outsourced Agency's Plant/Facility.
- During Installation & Commissioning Activities/Stages.
- Prior to Clearing of the completed installation for commissioning.
- Any other stage as find appropriate by TPCODL during contract execution time.

All inspections and participations shall be carried out within maximum of two weeks of TPCODL giving written intimation to the Associate or receiving appropriate advance written inspection call from the Associate, unless otherwise specified elsewhere in the contract document.

12.2 Facilitating Inspection

The Associate shall provide all opportunities and information to TPCODL's engineers to get acquainted with the technical know-how and the methods and practices adopted by the Associate in basic and detail engineering. The Associate shall provide documents, drawings, calculations etc. as may be required by TPCODL's Engineers.

The Associate shall provide free of charge office accommodation, office facilities, secretarial services, communication facilities, general and drawing office stationary, etc. as may be reasonably required by the TPCODL's engineers. Similarly, facilities shall also be provided by Associate's outsource agencies/partners/authorized dealers (collectively termed as sub-associates) if such basic and detail engineering activities are carried out in the design offices of sub-Associates.

Doc. Title	GENERAL CONDITIONS OF CONTRACT - COMPOSITE WORKS	
Rev. No	0	Page 20 of 104

The Associate shall be responsible for the safety of employees of TPCODL/Third Party Agency when they are at the Associate's /Associate's outsource agency's plant or facility for carrying out/witnessing inspection/testing. All statutory safety precautions as applicable shall be followed by the Associate during Inspection Testing. If TPCODL inspectors are not satisfied with the safety arrangements at the plant, TPCODL have the right to call off inspection till such time corrective action is taken by the Associate.

Before raising the call for pre-dispatch final inspection and testing, the Associate shall conduct all the tests—type tests, routine tests etc-as specified in the contract document and submit copies of the test certificates to TPCODL along with the inspection call, for scrutiny of TPCODL.

The Associate and TPCODL shall jointly document all the observations, comments and action points after completion of inspection and it shall be binding on the Associate to provide compliance on all the points requiring compliance and furnish the compliance report to the designated authority of TPCODL for receiving clearance for dispatch of materials.

12.3 Third Party Nomination

TPCODL also may nominate a third party for the purpose of carrying out the inspection and such an agency shall be entitled to all the rights and privileges of TPCODL as far as conducting the inspection.

12.4 Waiver of Inspections

TPCODL on its own discretion shall chose to waive off any inspection and ask the Associate to submit all the test reports as applicable as per contract specifications, related to inspection and testing of the goods ordered for scrutiny and clearance for dispatch.

12.5 Incorrect Inspection Call

In case it is observed that the material offered for inspection is not ready at the time of TPCODL inspection visit rendering it as futile, all costs towards such inspection shall be recovered from the BA. Taxes as applicable on such recoveries shall be borne by the BA.

13.0 MDCC & DELIVERY OF MATERIALS

13.1 Material Dispatch Clearance Certificate

Associate shall deliver material/goods/equipment against Supply Contracts or Supply Part of Composite/Service Contracts only after receiving Material Dispatch Clearance Certificate (hereafter termed as MDCC) issued by designated authority of TPCODL. Material delivered at TPCODL stores or at project site without a valid MDCC issued by the designated official of TPCODL shall be rejected. MDCC shall be issued to associate furnishing compliance report on the action points documented during pre-dispatch inspection and testing at Associate's/ Sub-Associate's plant/ facility. In case Pre-dispatch inspection is waived at the discretion of TPCODL, then, MDCC shall be issued on receiving all the test reports-routine& type-from the Associate and finding them in order.

The associate shall include and provide for securely protecting and packing the materials so as to avoid loss or damage during handling and transport by air, sea, rail and road or any other means.

All such packing shall allow to the extent possible for easy removal and checking at Site. The associate shall take special precautions to prevent rusting of steel and iron parts during

Doc. Title	GENERAL CONDITIONS OF CONTRACT - COMPOSITE WORKS	
Rev. No	0	Page 21 of 104

transit by sea. Gas seals or other materials shall be utilised by the associate for protection against moisture during transit of all Plant and Equipment.

Each Equipment or parts of Equipment shall be tagged with reference to the assembly drawings and corresponding part numbers. Each bale or package shall contain a packing note quoting specifically the name of the associate, item description, quantity, item / package identification.

All packing cases, containers, packing and other similar materials shall be new and supplied free by the associate and it shall not be required to be returned to the associate.

Notwithstanding anything stated in this clause, the associate shall be entirely responsible for loss, damage or depreciation or deterioration to the materials and supplies due to faulty and/or insecure packing or otherwise during transportation to the Site until otherwise provided herein.

In case of the consignments dispatched by road, the associate shall ensure that it or its sub-contractors:

- i) Identify and obtain the correct type of trucks/trailers, keeping in view the nature of consignments to be dispatched.
- ii) Take such actions as may be necessary to avoid all possible chances of damages during transit and to ensure that all packages are firmly secured.

Timelines for inspection and MDCC is as below:

S. No.	Inspection	MDCC issuance time including inspection time (max.)
1	Outside Bhubaneswar	12 days
2	Within Bhubaneswar	5 days
3	Waiver*	3 working days

* Associate is expected to raise the inspection call assuming that Inspection shall be carried out by TPCODL. The decision for waiver of inspection shall be on sole discretion of TPCODL.

13.2 Right to Rejection on Receipt

Goods/Material/Equipment delivered in condition physically damaged & incomplete as a product ordered, or not packed and transported as per the terms and conditions of the contract is liable to be rejected. Such item shall be lifted back by Associates within 15 days from receipt of rejection note from TPCODL and have to supply back the material within next 30 days or within the timeframe mutually decided by Associate and TPCODL.

If delivery of the material is beyond the agreed time, Liquidated damage clause, mentioned in this GCC separately shall be applicable; but the period for levy of LD shall be considered as per the original delivery schedule and not from the agreed timelines for material rectification.

13.3 Consignee

Unless otherwise specified in the Contract Document, Materials/Goods/Equipment shall be consigned to "Stores-In-Charge", TPCODL Bhubaneswar.

13.4 Submission of mandatory documents on Delivery

Doc. Title	GENERAL CONDITIONS OF CONTRACT - COMPOSITE WORKS	
Rev. No	0	Page 22 of 104

Following documents shall be mandatorily submitted by BA along with supply of material to TPCODL stores/site:

S. No.	Documents	Requisite
1	Invoice copy in original	With all consignments
2	LR copy	Wherever required
3	Packing list	With all consignments
4	MDCC	With all consignments
5	Purchase order / Release order	Signed copy
6	Test certificates	With all consignments
7	Inspection/JVR report	In case pre-dispatch inspection is conducted
8	Device data in CD as per template for metering items	Wherever applicable

13.5 Dispatch and Delivery Instructions

S. No.	Instructions
1	Purchase order/ Release order no. shall be mentioned on invoice and on material
2	TPCODL material code and material description shall be mentioned in invoice and on material.
3	"Property of TPCODL" shall be embossed on material.
4	The material shall be properly sealed and packed in standard packing as per purchase order terms & conditions.
5	The weight and quantity of material shall be mentioned wherever applicable
6	The material supplied shall be co-related with the packing list.
7	The name plate detail on equipment shall include Material code, Material description, specification detail of material [as applicable], Serial No. Year of manufacturing, PO/RO no. and date, "PROPERTY OF TPCODL, Bhubaneswar", Guarantee period and Associate's name.
8	In case of manual unloading, supplier / transporter shall deploy sufficient Labour for unloading the material at TPCODL central store. For heavy item(s), crane will be provided by TPCODL [unloading cost will be recovered from the associate].
9	The driver should have valid License and one helper in truck. All the documents of truck like registration papers, PUC etc. should be available in Truck.
10	BA representative should accompany the material and get it unloaded / stacked in his presence wherever possible.

14.0 GUARANTEE

14.1 Guarantee of Performance

Associates shall stand guarantee that the equipment and material supplied/service or work rendered under the contract is free from design, manufacturing, material, construction, erection & installation and workmanship & quality defects and is capable of its due, rated and intended quality performance, as an integrated product delivered under the contract. for a specific period termed as Guarantee Period(as elaborated elsewhere in this clause) The

Doc. Title	GENERAL CONDITIONS OF CONTRACT - COMPOSITE WORKS	
Rev. No	0	Page 23 of 104

Associate should also guarantee that the equipment/material is new and unused except for the usage required for the tests and checks required as part of quality assurance.

14.2 Guarantee Period

The Guarantee Period will be equipment/service/work specific and shall be as specified in the Standard Specifications of TPCODL for the equipment/material/service/work and where standard specifications are not part of contract documents or guarantee period is not specified in the standard specifications,, the guarantee period shall be as per the Special Terms and Conditions of the Contract. In case of no mention of the guarantee period in standard specifications or SCC, Guarantee Period will be 15 Months from the Date of Commissioning or 24 months from the date of delivery of final lot of supplies made, whichever is earlier.

14.3 Failure in Guarantee Period (GP)

If the equipment and material supplied/service or work rendered under the contract fails to perform its due, rated & intended quality performance, during the Guarantee period, the associate is liable to undertake repair/rectify/replace the equipment and material supplied/service or work rendered under the contract within time frame specified in the SCC or elsewhere in the contract documents at associate's cost to make the equipment and material supplied/service or work rendered under the contract of performing its due, rated and intended quality performance. If Associate fails to repair/rectify/replace the equipment or material supplied/service or work rendered under the contract, failed in Guarantee Period, TPCODL will be at liberty to get the same done at Associate's risks and costs and recover all such expenses plus the TPCODL's own charges (@ 20% of expenses incurred), from the Associate or from the "Security cum Performance Deposit" as the case may be.

If during the Warranty/ Guarantee period some parts of the supplies are replaced owing to the defects/ damages under the Warranty, the Warranty period for such replaced parts shall be until the expiry of twelve months from the date of such replacement or renewal or until the end of original Guarantee period, whichever is later.

Any repairs during the Guarantee Period shall be carried out by the Associate within 30 days of reporting the issue to Associate by TPCODL. However, if replacement of the Equipment is required, Associate shall notify the same to TPCODL within 7 days of reporting the issue by TPCODL. Thereafter, the total time for supply of new equipment/ material shall be equal to the original delivery period of that equipment/ material as specified in the Contract. In case the Associate is not able to rectify/ replace the faulty equipment/ material within the stipulated timelines as mentioned above, penalty shall be levied as per the Liquidated Damages clause mentioned in this document. The penalty amount shall be recovered from the payment due to the vendor or by encashment of the SPBG as the case may be.

14.4 Cost of repairs on failure in GP

The cost of repairs/rectification /replacement, apart from the actual cost of repairs/rectification/replacement is also inclusive of all associate costs of required transportation, site inspection /mobilization/dismantling and re-installation costs as applicable, to be borne by the Associate. The Associate has to ensure that the interruption in the usage of intended purpose of the equipment is minimized to the maximum extent In lieu of the time taken for repairs/rectification/replacement.

Doc. Title	GENERAL CONDITIONS OF CONTRACT - COMPOSITE WORKS	
Rev. No	0	Page 24 of 104

14.5 Guarantee period for Goods Outsourced

If the Associate outsources partly equipment/materials/services from third party as mutually agreed upon at the pre award stage of contract, TPCODL shall have the benefit of any additional guarantee period if provided by the third party for the part supplied/executed by them.

14.6 Latent Defect

Hidden defects in manufacturing or design of the product supplied and which could not be identified by the tests conducted but later manifested during operation of the equipment are termed as latent defects. Associates shall further be responsible for 'free replacement' for another period of THREE years from the end of the guarantee period for any 'Latent Defects' if noticed and reported by the Company.

14.7 Support beyond the Guarantee Period

The Associate shall ensure availability of spares and necessary support for a period of at least 10 years post completion of guarantee period of equipment supplied against the contract.

15.0 LIQUIDATED DAMAGES

Liquidated damages @1% of the total executed contract value per week or part thereof, for the period of delay in integrated completion, subject to maximum 10% of the value of the contract shall become leviable without prejudice to other rights of the TPCODL. This amount shall be recoverable from any amount due or becoming due to the Business Associates under this or any other contract. In specific cases, TPCODL reserves the right to apply LD only on the unexecuted portion of the supply and works for standalone use, provided full quantity is executed within a maximum 30% additional time. Deduction of LD shall be on landed cost i.e contract value inclusive of taxes and in pursuant statutory compliance GST would be applicable at the stipulated rate and the same shall be borne by Business Associate. In case of LD deduction, a GST invoice shall be issued by TPCODL as a proof of deduction/ recovery.

15.1 LD Waiver Request

Any request of LD waiver shall be submitted within thirty (30) days of deducting LD. Request submitted beyond the timeline shall not be entertained.

15.2 Material Recovery

In case of any recoveries for materials or services (for material free issued by TPCODL and not reconciled by BA or for services claimed and paid in excess at the time of running bills), the total cost which shall be recovered from the BA, shall be the gross amount of material or services (i.e. including taxes) plus applicable taxes as prevailing at the time of such recoveries.

16.0 ASSIGNMENT OR SUBCONTRACTING

Associates shall not assign/subcontract/outsourced the schedule of activities of contract TPCODL enters with the associate, in part or full, without TPCODL's prior written approval.

Doc. Title	GENERAL CONDITIONS OF CONTRACT - COMPOSITE WORKS	
Rev. No	0	Page 25 of 104

However outsourcing of materials/equipment/services by Associate to make the integrated product for which TPCODL's has placed the contract with the associate from suppliers, makes and agencies which have been mutually agreed upon during contract pre-award stage is permitted subject to following conditions.

In such cases where outsourcing is done by the Associate

- Shall ensure that outsourced suppliers comply with the technical and financial qualification requirements specified by TPCODL in the contract document
- Shall furnish all particulars about the proposed outsourcing agencies and the details of the goods/services/work outsourced to the Associate while seeking approval of TPCODL for inclusion for outsourcing. The Associate shall give approval or shall refuse approval in writing within thirty (30) days of receipt of such request. However the Associate shall not be entitled for any additional contract execution time whatsoever in lieu of the process for approval for outsourcing agencies, and shall be held responsible for any delay in the project execution time.
- Shall remain jointly and severally liable for any action, deficiency, and/or negligence on the part of his outsourcing agencies. The approval extended by the Associate to outsourcing agencies recommended by the Associate shall not discharge the later from his Contract obligations.

Shall submit to the Associate unpriced copies of purchase orders with technical specifications included in the orders, placed on outsourcing agencies as soon as the respective orders have been placed by the Associate.

17.0 UNLAWFUL ACTIVITIES

The Associate shall have to ensure that none of its employees are engaged in any unlawful activities (whether covered under the scope of the present GCC or not) subversive of the TPCODL's interest failing which appropriate action (legal or otherwise) may be taken against the Associate by the TPCODL, in accordance with the terms of the present GCC.

18.0 CONFIDENTIALITY

Associate and its employees or representatives thereof shall strictly maintain the confidentiality of various information they come across while executing the contract as detailed below.

18.1 Documents

All maps, plans, drawings, specifications, schemes and other documents or information related to the Contract/Project and the subject matter contained therein and all other information given to the Associate by the TPCODL in connection with the performance of the contract shall be held confidential by the Associate and shall remain the property of the TPCODL and shall not be used or disclosed to third parties by the Associate for any purpose other than for which they have been supplied or prepared. The Associate may disclose to third parties, upon execution of confidentiality agreements, such part of the drawings, specifications or information if such disclosure is necessary for the performance of the Work provided such third parties agree in writing to keep such information confidential to the same extent and degree as provided herein, for the benefit of the TPCODL.

18.2 Geographical Data

Doc. Title	GENERAL CONDITIONS OF CONTRACT - COMPOSITE WORKS	
Rev. No	0	Page 26 of 104

Maps, layouts and photographs of the unit/plant including its surrounding regions showing vital installation for national security of country or those of TPCODL shall not be published or disclosed to the third parties or taken out of the country without prior written approval of the TPCODL and upon execution of confidentiality agreements satisfactory to the TPCODL with such third parties prior to disclosure.

18.3 Associate's Processes

Title to secret processes if any developed by the Associate on an exclusive basis and employed in the design of the equipment shall remain with the Associate. TPCODL shall hold in confidence such processes and shall not disclose such processes to the third parties without prior approval of the Associate and execution by such third parties of secrecy agreements satisfactory to the Associate prior to disclosure. Upon completion of contract, such processes shall become the property of the TPCODL. Title to technical specifications, drawings, flow sheets, norms, calculations, diagrams, interpretations of test results, schematics, layouts and such other information, which the Associate has supplied to the TPCODL under the Contract shall be passed on to the TPCODL. The TPCODL shall have the right to use these for construction, erection, start-up, Trial Run, operation, maintenance, modifications and/or expansion of the works including for the manufacture of spare parts.

18.4 Exclusions

The provision of Clauses 16.1 to 16.3 shall not apply to information:

- Which at the time of disclosure are in the public domain which later on become part of public domain through no fault of the party concerned, or
- Which were in the possession of the party concerned prior to disclosure to him by the other party, or
- Which were received by the party concerned after the time of disclosure without restriction on disclosure or use, from a third party who did not acquire such information directly or indirectly from the other party or has no obligation of confidentiality for such information.

18.5 Violation

In case of violation of this clause, the Associate is liable to pay compensation and damages as may be determined by the competent authority of TPCODL.

19.0 INTELLECTUAL PROPERTY RIGHTS

If, in the course of performance of its functions and duties as envisaged by the scope of the present GCC, the Associate acquires or develops, any unique knowledge or information which would be covered, or, is likely to be covered within the definition of a trademark, copyright, patent, business secret, geographical indication or any other form of intellectual property right, it shall be obliged, under the terms of this present GCC, to share such knowledge or information with the TPCODL. All rights, with respect to, or arising from such intellectual property, as afore mentioned, shall solely vest in TPCODL.

Moreover, the Associate undertakes not to breach any intellectual property right vesting in a third party/parties, whether by breach of statutory provision, passing off, or otherwise. In the event of any such breach, the Associate shall be wholly liable to compensate, indemnify or make good any loss suffered by such third party/parties, or any compensation/damages

Doc. Title	GENERAL CONDITIONS OF CONTRACT - COMPOSITE WORKS	
Rev. No	0	Page 27 of 104

arising from any legal proceeding/s, or otherwise. No liability of TPCODL shall arise in this respect, and any costs, damages, expenses, compensation payable by TPCODL in this regard to a third party/parties, arising from a legal proceeding/s or otherwise, shall be recoverable from the Associate.

20.0 INDEMNITY

The Associate shall at all times indemnify, keep indemnified and hold harmless the TPCODL and its officers, directors, employees, affiliates, agents, successors and assigns against all actions, claims, demands, costs, charges and expenses arising from or incurred by reason of any infringement of patent, trade mark, registered design, copy rights and/or industrial property rights by manufacture, sale or use of the equipment supplied by the Associate whether or not the TPCODL is held liable for by any court judgement. In this connection, the TPCODL shall pass on all claims made against him to the Associate for settlement.

The Associate assumes responsibility for and shall indemnify and save harmless the TPCODL from all liability, claims, costs, expenses, taxes and assessments including penalties, punitive damages, attorney's fees and court costs which are or may be required to be paid by the TPCODL and its officers, directors, employees, affiliates, agents, successors and assigns arising from any breach of the Associate's obligations under the Contract or for which the Associate has assumed responsibilities under the Contract including those imposed under any local or national law or laws, or in respect to all salaries, wages or other compensation for all persons employed by the Associate or his Sub-Associates or suppliers in connection with the performance of any work covered by the Contract. The Associate shall execute, deliver and shall cause his Sub-Associate and suppliers to execute and deliver, such other further instruments and to comply with all the requirements of such laws and regulation as may be necessary there under to conform and effectuate the Contract and to protect the TPCODL.

The TPCODL shall not be held responsible for any accident or damages incurred or claims arising, due to the Associate's error there from prior to completion of work. The Associate shall be liable for such accidents and after completion of work for such accidents as the case may be due to negligence on his part to carry out Work in accordance with Indian laws and regulations and the specifications set forth herein.

21.0 LIABILITY & LIMITATIONS

21.1 Liability

Except for any specific liability which may be identified in the Contract and which may be payable hereunder, Associate shall not be liable for any special, incidental, indirect, or consequential Damages or any loss of business Contracts, revenues or other financial loss (or equivalents thereof no matter how claimed, computed or characterized) arising out of or in connection with the Performance of the Work or supply of Goods ***unless caused by Associate's negligence, willful misconduct or breach of contract.***

TPCODL shall have no liability or any special, incidental, indirect or consequential Damages for any loss of Business Contracts, revenues or other financial loss arising out of this Contract.

21.2 Limitation of Liability

Doc. Title	GENERAL CONDITIONS OF CONTRACT - COMPOSITE WORKS	
Rev. No	0	Page 28 of 104

The total liability of Associate against any contract shall be limited to the Total All Inclusive Contract Value.

22.0 FORCE MAJEURE

Force Majeure applies if the performance by either Party ("the Affected Party") of its obligations under Contract is materially and adversely affected.

"Force Majeure" shall mean any event or circumstance or combination of events or circumstances referred below and their consequences that wholly or partly prevents or unavoidably delays any Party in the performance of its obligations under this Agreement, but only and to the extent that such events and circumstances are not within the reasonable control, directly or indirectly, of the Affected Party and could not have been avoided even if the Affected Party had taken reasonable care:

- Act of war (whether declared or undeclared), invasion, armed conflict or act of foreign enemy, embargo, blockade, revolution, riot, bombs, religious strife or civil commotion, etc.
- Politically motivated sabotage, or terrorism, etc.
- Action or Act of Government or Governmental agency for which remedy is beyond the control of the affected parties.
- Any act of God.

Note: Causes like power breakdown/ shortages/fire/strikes, accidents etc do not fall under Force Majeure.

Time being the essence of the Contract, if either party is prevented from the performance of its obligations in whole or in part due to an event of Force Majeure, then provided Notice of happening of any event by the Affected Party is given to the other party within seven (7) days from the date of occurrence of such event, which DIRECTLY has impact on works and submitted details and quantum of resulting effect, but at the same time had made all possible efforts to mitigate and overcome effects thereof, the Affected Party's performance under this Contract shall be suspended until such event ceases and the Scheduled Completion shall be delayed accordingly.

If Force Majeure event(s) continue for a period of more than three months, the parties shall hold consultation to discuss the further course of action.

Neither party shall be considered to be in default or in breach of its obligation under the Contract to the extent that performance of such obligation by either party is prevented by any circumstances of Force Majeure which arise after effective date of Contract.

Neither party can claim any compensation from the other party on account of Force Majeure.

23.0 SUSPENSION Of CONTRACT

23.1 Suspension for Convenience

TPCODL may, at any time and at its sole option, suspend execution of all or any portions of the schedule of items of contract to be supplied/work to executed by Associate under the contract by providing to the Associate at least two business days written notice for contracts having contract completion period less than sixty days and at least seven business days' notice for all other contracts.

Doc. Title	GENERAL CONDITIONS OF CONTRACT - COMPOSITE WORKS	
Rev. No	0	Page 29 of 104

Upon receipt of any such notice, the Associate shall respond as follows as applicable as per contract construction.

- Immediately discontinue further supply of material/goods specified in the suspension notice for supply contracts
- Immediately discontinue further service/work and supply of materials of those services/materials/work specified in the suspension notice for service /composite contract
- Promptly make every reasonable effort to obtain suspension, upon terms satisfactory to TPCODL, of all orders, outsourcing arrangements, and rental Contracts to the extent that they relate to performance of the portion of Work suspended by the notice.
- Protect and maintain the portion of the service/Work already completed, including the portion of the Work suspended hereunder, unless otherwise specifically stated in the notice.
- Continue delivering/carrying out the supply/service/work items as per contract conditions, which do not fall under purview of the suspension notice.

On receipt of resumption notice from TPCODL, the Associate shall resume execution of contract as specified in the resumption notice, within the time frame specified in the resumption notice,

23.2 Suspension for Breach of Contract conditions.

TPCODL shall suspend execution of whole/or part thereof the contract till such time Associate complies with the conditions stipulated under section clause 27 for breach/default of contract conditions.

23.3 Compensation in lieu of Suspension

If the suspension of the contract in whole or in part is for convenience of TPCODL and not due to any breach of contract conditions by the associate, TPCODL at its discretion shall consider compensating all reasonable additional costs incurred by Associate in lieu of suspension of whole or part of contract, on representation of the Associate providing justified estimates of such additional costs and such estimates are found acceptable and approved by competent authority of TPCODL.

If the suspension of contract in whole or part thereof is due to breach of contract conditions (refer clause 24.3) by the Associate, Associate shall not be entitled for any compensation for any cost incurred in lieu of suspension of whole or part of contract and also shall be liable for compensating all the losses arising to TPCODL in lieu of suspension of contract. Resumption notice shall be subject to the Associate taking corrective action for the breach of contract conditions within the time frame and as per the terms specified in the suspension notice.

24 TERMINATION OF CONTRACTS

24.1 Termination for Default/Breach of Contract

The contract / PO shall be subject to termination by TPCODL in case of breach of the contract by the Associate which shall include but not be limited to the following:

Doc. Title	GENERAL CONDITIONS OF CONTRACT - COMPOSITE WORKS	
Rev. No	0	Page 30 of 104

- a. Withdrawal or intimation by the Associate of its intent to withdraw or surrender the execution / completion of the contracted work /PO or failure in ensuring adherence to any delivery schedules, in deviation of the contract/ PO.
- b. Refusal or neglect on the part of the Associate to supply material/equipment of quantity or quality as specified by TPCODL and within the timeframe as specified in the contract document or refusal or neglect to execute the services/work in terms of the agreed standards of quantity or quality and/or within the timeframe specified in the contract/PO.
- c. Failure in any respect to perform any portion of the Work contracted with promptness, diligence, or in accordance with the terms of the contract.
- d. Failure to furnish guarantees as specified and /or failure to comply with the terms thereof.
- e. Failure to furnish such relevant documents or information within the time specified which may be necessary for due execution / completion of the works and documentation.
- f. Liquidation, bankruptcy either voluntary or involuntary OR entering into any composition or compromise with its creditors, or Insolvency.
- g. In case any reasonable information has been received by TPCODL that Associate has adopted/ or attempted to adopt any unethical conduct, action in award of the contract /PO or at any time thereafter.
- h. Failure to comply with applicable statutory provisions as contained in the contract or failure to comply with the applicable laws.
- i. Failure to comply with safety regulations/clauses stipulated in the contract or as may be generally instructed by TPCODL.

If the default or breach as specified under clause 24 (except sub clause g thereof) be committed by the associate for the first time, TPCODL shall issue, along the with notice of default or breach, a warning notice instructing the associate to take remedial/corrective action within the time frame stipulated in the warning notice and not to repeat the same in future. The timeframe for corrective action by the associate shall be specific to the nature of breach of contract and the same shall not be objected to by the Associate. If the Associate fails to comply with the instructions in the warning notice or in taking corrective action to the satisfaction of TPCODL then TPCODL may terminate the entire or part of contract at its discretion by issuing termination notice without incurring any liability on this ground.

In case the contract is terminated for any breach of the nature specified in clause 24 g stated above, TPCODL shall have the right to terminate all the contracts TPCODL is having with the Associate by issuing termination notice which shall be without prejudice to the other rights of TPCODL available to it under law.

Without prejudice to its right to terminate for breach of contract, TPCODL may, without assigning any reason, terminate the Contract in whole or in part at any time at its discretion while the contract is in force by serving a written notice of two weeks to the Associate.

In the event of TPCODL having proceeded with termination of the contract the associate shall comply and proceed further in the following manner:

- i) Associate shall discontinue the supply, on the expiry of the said period of two weeks.

Doc. Title	GENERAL CONDITIONS OF CONTRACT - COMPOSITE WORKS	
Rev. No	0	Page 31 of 104

ii) Associate shall ensure that no further steps are being taken towards discharge of the obligations, terms and conditions as contained in the contract/PO. This shall include initiation of actions not limited to discontinuation of other allied and associated arrangements which the associate might have entered into with third parties for due discharge of its obligations under the contract with TPCODL.

iii) The Associate shall perform thereafter such tasks as may be necessary to preserve and protect the terminated portion of the material/service/work in progress and the materials and equipment at TPCODL sites or in transit thereto. However the associate shall continue to fulfill its contractual obligations with regard to the part of contract not terminated.

iv) It shall be open for TPCODL to conduct a joint assessment with the associate of the material ,supplies, equipment ,works or in general as to the subject matter of the contract in regard to which the associate claims having completed its obligations before or during such termination.

v) It shall be open to TPCODL to seek invocation of the performance bank guarantee or any other guarantee or other security deposit by whatever name called submitted by the associate, which shall not be objected to or protested against by the associate.

In case of termination of the contract the parties agree to be governed inter alia by the following:

a) In case TPCODL exercises its right of termination as stated above the associate shall not dispute or object to the same.

b) The Associate shall be entitled to receive and claim only such payments OR sums of money from TPCODL as may be found payable to it in regard to works executed by it under the terms of the contract and no other claim of any nature whatsoever shall be made by the Associate.

c) All such provisions which the parties have agreed to survive and prevail even after termination of the contract shall remain effective despite the termination.

In the event of such termination, TPCODL may finish the Work by whatever method it may deem expedient, including the hiring of services and /or purchase of material equipment from such third parties as TPCODL may deem fit or may itself provide any labor or materials and perform any part of the Work. The associate undertakes to bear the incremental costs if any paid by TPCODL in such a case attributable to failure on the part of the associate. The Associate in such a case shall not be entitled to receive any further payments and any sums found payable to it may be adjusted by TPCODL against the amount recoverable from him on this ground. The same shall be without prejudice to other rights available to TPCODL under law against the associate.

Upon the termination of any of the contract due to occurrence of any circumstances provided in clauses stated above and constituting repeated breach or misconduct , TPCODL shall be entitled to bar the associates its agents , affiliates from undertaking any negotiation / tendering, bidding, participation activities concerning TPCODL for a period of two years from date of such termination. The same shall be without prejudice to other rights available to TPCODL.

24.2 Termination for convenience of Associate

Doc. Title	GENERAL CONDITIONS OF CONTRACT - COMPOSITE WORKS	
Rev. No	0	Page 32 of 104

Associate at its convenience may request for termination of contract, clearly assigning the reason for such request. TPCODL has full right to accept, reject or partially accept such request. This convenience will be available to associate only after one year from the contract effective date. For this purpose, associate will provide a notice period of 90 days to TPCODL, Associate will have to pay TPCODL a 'termination convenience fee' equivalent to 5% of unexecuted contract value.

24.3 Termination for Convenience of TPCODL

TPCODL at its sole discretion may terminate the contract by giving 30 days prior notice in writing or through email to the Associate. TPCODL shall pay the Associate for all the supplies/ services rendered till the actual date of contract termination against submission of invoice by the Associate to that effect.

25.0 DISPUTE RESOLUTION & ARBITRATION

In case of any dispute or difference the parties shall endeavor to resolve the same through conciliatory and amicable measures within 15 Days failing which the matter may be referred by either party for resolution by the sole arbitrator to be appointed mutually by both the parties. The arbitral proceedings shall be conducted in accordance with Arbitration and Conciliation Act 1996 and the place of arbitration shall be Bhubaneswar. The language to be used at proceedings shall be English and the award of the arbitrator shall be final and binding on the parties. The parties shall bear their respective costs of arbitration. The associate shall continue to discharge its obligations towards due performance of the works as per the terms of the contract during the arbitration proceedings unless otherwise directed in writing by TPCODL or suspended by the arbitrator. Further, TPCODL shall continue making such payments as may be found due and payable to the associate for such works.

25.1 Governing law and jurisdiction

The parties shall be subject to the jurisdiction of the courts of law in Bhubaneswar and any matter arising here from shall be subject to applicable law in force in India.

26.0 ATTRIBUTES OF GCC

26.1 Cancellation

The Company reserves the right to cancel, add, delete at its sole discretion, all or any terms of this GCC or any contract, order or terms agreed between the parties in pursuance without assigning any reasons and without any compensation to the Associates.

26.2 Severability

If any portion of this GCC is held to be void, invalid, or otherwise unenforceable, in whole or part, the remaining portions of this GCC shall remain in effect.

26.3 Order of Priority

In case of any discrepancies between the stipulations in General Conditions of the Contract (GCC) and Special Conditions of Contract (SCC), the GCC shall stand superseded by the SCC to the extent stipulated hereinabove while balance portion of respective clauses of GCC shall continue to be applicable.

27.0 INSURANCE

Doc. Title	GENERAL CONDITIONS OF CONTRACT - COMPOSITE WORKS	
Rev. No	0	Page 33 of 104

The Associate shall arrange accident insurance policy for his foreign experts/specialists/personnel deputed to Site and Associate's/his sub-Associates' manufacturing works as well as for his Indian engineers and supervisory staff. The Associate shall also take out for his Indian workmen, where applicable, a separate policy as required under Workmen's Compensation Act.

Associates shall be responsible to suitably insure their entire work-force (to the extent of at least meeting requirements under Workmen Compensation Act) Tools, Plant, Third party liability at the project site, All Risk comprehensive insurance for the entire works (insurance for free issue items will be in TPCODL scope) for total contract (PO/RO) value or any other such risks during execution of works, till the works are handed over to the company, in consultation with TPCODL and shall submit copies of such insurances to the Engineer-in-Charge for review / acceptance before commencing the work. Engineer-in-charge must ensure compliance to insurance requirement by Associate before commencement of works. TPCODL shall stand fully indemnified in this respect.

28.0 ERRORS AND OMISSIONS

The Associate shall be responsible for all discrepancies, errors and omissions in the drawings, documents or other information submitted by him, irrespective of whether these have been approved, reviewed or otherwise accepted by the TPCODL or not. However any error in design/drawing arising out of any incorrect data/written information from TPCODL will not be considered as error and omissions on part of the Associate.

29.0 TRANSFER OF TITLES

The title of ownership and property to all equipment, installations, erections, constructions materials, drawings & documents shall pass to the TPCODL after Commissioning and complete handing over-taking over.

However, such passing of title of ownership and property to the TPCODL shall not in any way absolve, dilute or diminish the responsibility and obligations of the Associate under this Contract including loss or damages and all risks, which shall vest with the Associate.

The Associate shall take all corrective measures arising out of discrepancies, errors and omissions in drawings and other information within the time schedule and without extra cost to the TPCODL.

The Associate shall also be responsible for any delay and/or extra cost if any, in carrying out engineering, and site works by other agencies arising out of discrepancies, errors and omissions stated in as well as of any late revision/s of drawings and information submitted by the Associate.

30.0 SUGGESTIONS & FEEDBACK

We welcome all our Business Associates to write to us about their experience with TPCODL; be it our Company, our services or our people. Each and every concern, issue, query and suggestion from you will help us to become a better company to work with and shall help us develop a strong bonding of trust and a long term relationship with you.

You may send your feedback by filling up our Business Associate Feedback Form enclosed herewith as Annexure-I. You can also log on to our website www.tpcentralodisha.com to provide your feedback according to the guidelines mentioned below:

Doc. Title	GENERAL CONDITIONS OF CONTRACT - COMPOSITE WORKS	
Rev. No	0	Page 34 of 104

31.0 CONTACT POINTS

In case Business Associate needs information with respect to payments or has any grievances, same may be lodged by log on to our website www.tpcentralodisha.com

32.0 LIST OF ANNEXURES

S. No.	Subject	Annexure
1.	Performa for Bid Security Bank Guarantee	A
2.	Performa for Advance Payment Bank Guarantee	B
3.	Performa for Performance Bank Guarantee (CP cum EP)	C
4.	Performa for No Demand Certificate by Associate	D
5.	Performa for Indemnification on Statutory Compliance	E
6.	Performa For Application For Issuance of Consolidated TDS Certificate	F
7.	HR Service Level Agreement	G
8.	Under taking for competence of workmen	H
9.	Business Associate Feedback Form	I
10.	Acceptance Form For Participation In Reverse Auction Event	J
11.	NEFT or RTGS payment request form	K
12.	Contractor Safety Management System	L
13.	Vendor Appraisal Form	M
14.	Manufacturers Authorization Form	N

Doc. Title	GENERAL CONDITIONS OF CONTRACT - COMPOSITE WORKS	
Rev. No	0	Page 35 of 104

ANNEXURE-A

PROFORMA FOR BID SECURITY BANK GUARANTEE

TP Central Odisha Distribution Limited

Bhubaneswar

WHEREAS, (Name of the Bidder) _____ (hereinafter called "the BIDDER") has submitted his bid dated _____ for the (Name of Contract) _____ (hereinafter called "the BID").

KNOW ALL men by these presents we (Name of the Bank) _____ of (Name of the Country) _____ having our registered office at _____ (hereinafter called "the BANK) are bound unto TP Central Odisha Distribution Limited (TPCODL) in the sum of _____ for which payment well and truly to be made to the TPCODL the Bank binds himself, his successors and assigns by these presents.

SEALED with the Common Seal of the said Bank this _____ day of _____ 20_____.

The CONDITIONS of this obligation are:

i) If the Bidder withdraws his Bid during the period of bid validity specified in the Proforma of Bid

or

ii) If the Bidder having been notified of the acceptance of his Bid by the TPCODL during the period of bid validity fails or refuses to furnish the Contract Performance Bank Guarantee, in accordance with the Instructions to Bidders.

We undertake to pay the TPCODL upto the above amount upon receipt of its first written demand, provided that in its demand the TPCODL will note that amount claimed by it is due to it owing to the occurrence of one or both conditions, specifying the occurred condition or conditions.

This Guarantee will remain in force upto and including the date (No of days as mentioned in tender enquiry) days after the closing date of submission of bids as stated in the Invitation to Bid or as extended by you at any time prior to this date, notice of which extension to the Bank being hereby waived, and any demand in respect thereof should reach the Bank not later than the above date.

DATE.....

SIGNATURE

OF

THE

BANK.....

WITNESS.....

SEAL.....

(Signature, Name & Address)

(At least 2 witnesses)

Doc. Title	GENERAL CONDITIONS OF CONTRACT - COMPOSITE WORKS	
Rev. No	0	Page 36 of 104

ANNEXURE-B

PROFORMA FOR ADVANCE PAYMENT BANK GUARANTEE

(On Rs.100/- Stamp Paper)

Note:

- (a) Format shall be followed in toto
- (b) Claim period of six months must be kept up
- (c) The guarantee to be accompanied by the covering letter from the bank confirming the signature to the guarantee

TP Central Odisha Distribution Limited
Bhubaneswar

Advance Payment B.G.No.....

Contract No.....dated.....

1. You have entered into a Contract No _____ with M/s. _____ (hereinafter referred to as "the Vendor") for the supply and delivery of _____ (hereinafter referred to as" the said Equipment") for the price and on the terms and conditions contained in the said contract.
2. In accordance with the terms of the said contract, you have agreed to make an advance payment of Rs. _____ (Rupees _____ only) being _____% (_____percent) of the total value of the contract on "the Vendor" furnishing you with an irrevocable, unconditional and acceptable bank guarantee to be valid till the date of receipt of "the said equipment" covered by your above mentioned contract. For this purpose you have agreed to accept our guarantee.
3. In consideration thereof, we, _____ hereby irrevocably and unconditionally guarantee to pay to you on demand but in any case before the end of five working days from the date of the claim and without demur and without reference to "the Vendor" such amount or amounts not exceeding the sum of Rs. _____ (Rupees _____ only) being _____% (_____percent) of the total value of the contract on receipt of your intimating that "the Vendor" has not fulfilled his contractual obligations. You shall be the sole judge for such non-fulfillment and "the Vendor" shall have no right to question such judgment.
4. You shall have the right to file / make your claim on us under the guarantee for a further period of three months from the date of expiry.
5. This guarantee shall not be revoked without express consent and shall not be affected by your granting time or any other indulgence to "the Vendor", which shall include but

Doc. Title	GENERAL CONDITIONS OF CONTRACT - COMPOSITE WORKS	
Rev. No	0	Page 37 of 104

not be limited to, postponement from time to time of the exercise the same in you or any right which you may have against "the Vendor" and to exercise the same in any covenant contained or implied in the said contract or any other course or remedy or security available to you, and our Bank shall not be released from its obligations under this guarantee by your exercising any of your rights with reference to matters aforesaid or any of them or by reasons of any other act or forbearance or other acts of omission or commission on your part or any other indulgence shown by you or by any other matter or thing whatsoever which under the law would, but for this provision have the effect of relieving our bank from its obligation under this guarantee.

6. We also agree that you shall be entitled at your option to enforce this guarantee against our bank as a principal debtor, in the first instance, notwithstanding any other security or guarantee that you may have in relation to "the Vendor's" liabilities in respect of the premises
7. This guarantee shall not be affected by any change in the constitution of our Bank or "the Vendor" or for any other reason whatsoever.
8. Any claim / extension under the guarantee can be lodge-able at outstation banks or at Bhubaneswar branch and claim will also be payable at Bhubaneswar Branch **(to be confirmed by Bhubaneswar Branch by a letter to that effect)**
9. Notwithstanding anything herein contained, our liability under this guarantee is limited to Rs. _____ (Rupees _____ only) and the guarantee will remain in force upto and including _____ (Date) and shall be extended from time to time for such period or period as may be desired by "the Vendor".
10. Unless a demand or claim under this guarantee is received by us in writing within one month from _____ (expiry date) i.e. on or before _____ (claim period end date), we shall be discharged from all liabilities under this guarantee thereafter.

Dated at _____ this _____ day of _____ 200_____

Witness

- | | |
|----------|--|
| 1. _____ | Bank's rubber stamp
Banks full address |
| 2. _____ | Designation of Signatory
Bank official number |

Doc. Title	GENERAL CONDITIONS OF CONTRACT - COMPOSITE WORKS	
Rev. No	0	Page 38 of 104

ANNEXURE- C

PROFORMA FOR PERFORMANCE BANK GUARANTEE (CP cum EP)

(On Rs.100/- Stamp Paper)

Note:

- (a) Format shall be followed in toto
- (b) Claim period of one month must be kept up
- (c) The guarantee to be accompanied by the covering letter from the bank confirming the signature to the guarantee

TP Central Odisha Distribution Limited

Bhubaneswar

CP cum EP BG No.....

Order/Contract No.....dated.....

1. You have entered into a Contract No _____ with M/s. _____ (hereinafter referred to as "the Vendor") for the supply cum erection / civil work of _____ (hereinafter referred to as "the said Equipment") for the price and on the terms and conditions contained in the said contract.
2. In accordance with the terms of the said contract, "the Vendor" agreed to furnish you with an irrevocable, unconditional and acceptable bank guarantee for 10% of the value of contract and to be valid till the end of Guarantee period plus one month towards "Contract cum Equipment performance". For this purpose you have agreed to accept the guarantee.
3. In consideration thereof, we, _____ hereby irrevocably and unconditionally guarantee to pay to you on demand but in any case before the end of five working days from the date of the claim and without demur and without reference to "the Vendor" such amount or amounts not exceeding the sum of Rs. _____ (Rupees _____ only) being _____% (_____ percent) of the total value of the contract on receipt of your intimating that "the Vendor" has not fulfilled his contractual obligations. You shall be the sole judge for such non-fulfillment and "the Vendor" shall have no right to question such judgment.
4. You shall have the right to file / make your claim on us under the guarantee for a **further period of three month** from the date of expiry.
5. This guarantee shall not be revoked without express consent and shall not be affected by your granting time or any other indulgence to "the Vendor", which shall include but not be limited to, postponement from time to time of the exercise the same in you or any right which you may have against "the Vendor" and to exercise the same in any covenant contained or implied in the said contract or any other course or remedy or security

Doc. Title	GENERAL CONDITIONS OF CONTRACT - COMPOSITE WORKS	
Rev. No	0	Page 39 of 104

available to you, and our Bank shall not be released from its obligations under this guarantee by your exercising any of your rights with reference to matters aforesaid or any of them or by reasons of any other act or forbearance or other acts of omission or commission on your part or any other indulgence shown by you or by any other matter or thing whatsoever which under the law would, but for this provision have the effect of relieving our bank from its obligation under this guarantee.

6. We also agree that you shall be entitled at your option to enforce this guarantee against our bank as a principal debtor, in the first instance, notwithstanding any other security or guarantee that you may have in relation to "the Vendor's" liabilities in respect of the premises
7. This guarantee shall not be affected by any change in the constitution of our Bank or "the Vendor" or for any other reason whatsoever.
8. Any claim / extension under the guarantee can be lodge-able at outstation banks or at Bhubaneswar branch and claim will also be payable at Bhubaneswar Branch (to be confirmed by Bhubaneswar Branch by a letter to that effect in case BG is from the branch outside Bhubaneswar)
9. Notwithstanding anything herein contained, our liability under this guarantee is limited to Rs. _____ (Rupees _____) only and the guarantee will remain in force upto and including _____ (Date) and shall be extended from time to time for such period or period as may be desired by "the Vendor".
10. Unless a demand or claim under this guarantee is received by us in writing within one months from _____ (expiry date) i.e. on or before _____ (claim period end date), we shall be discharged from all liabilities under this guarantee thereafter.

Dated at _____ this _____ day of _____ 200__

Witness

- | | |
|----------|--------------------------|
| 1. _____ | Bank's rubber stamp |
| | Banks full address |
| 2. _____ | Designation of Signatory |
| | Bank official number |

Doc. Title	GENERAL CONDITIONS OF CONTRACT - COMPOSITE WORKS	
Rev. No	0	Page 40 of 104

ANNEXURE-D

PROFORMA FOR “NO DEMAND CERTIFICATE” BY ASSOCIATE

(On Company’s Letter head or with Company Seal)

(To be submitted by the Associate to TPCODL Accounts Department at the time of receipt of full and final payment)

(Certificate No. CCP/002)

Name of the Project

Order/ Contract No.

Dated

Name of the Associate

Scheme No. / Job No.

We, M/s. _____ (Associate) do hereby acknowledge and confirm that we have received the full and final payment due and payable to us from TPCODL, in respect of our aforesaid Order No _____ dated _____ including amendments, if any, issued by TPCODL to our entire satisfaction and we further confirm that we have no claim whatsoever pending with TPCODL under the said contract / W.O.

Notwithstanding any protest recorded by us in any correspondence, documents, measurement books and / or final bills etc., we waive all our rights to lodge any claim or protest in future under this contract.

We are issuing this “NO DEMAND CERTIFICATE” in favour of TPCODL, with full knowledge and with our free consent without any undue influence, misrepresentation, coercion etc.

Dated

Signature

Place

Name

Designation

(Company Seal)

Doc. Title	GENERAL CONDITIONS OF CONTRACT - COMPOSITE WORKS	
Rev. No	0	Page 41 of 104

ANNEXURE – E

PROFORMA FOR “INDEMNIFICATION ON STATUTORY COMPLIANCES”

(To be submitted by the successful Bidder within seven days of award of work)

(Certificate No. CCP/001)

Name of the Project

Letter of Award / Contract No.

Dated

Name of the Associate

Scheme No. / Job No.

By this confirmation we, _____
(Associate) are formally bound to M/s. TPCODL towards any sum which may be imposed, levied or hereinafter recovered by the Provident Fund Organization under the provisions of the Employees of the Provident Fund and Miscellaneous Provisions Act 1952 in respect of employees employed by us.

We well and truly bind ourselves and our heirs executors administrators and representatives jointly severally and respectively for the above payment only to be paid to M/s. TPCODL.

AND WHEREAS we, _____ (Associate) is making compliance of the Employees Provident Fund and Miscellaneous Provisions Act 1952, have entered into the above written bond for the indemnity to M/s. TPCODL against all losses from the acts or default of the said Associate in respect of compliance of the Provident Fund Act.

Similarly we hereby confirm that we have complied with all statutory and local laws and nothing is outstanding with regard to Local Sales Tax, Labour Laws, Local Municipal dues, Electricity dues etc. We have entered into the above written bond for the indemnity to M/s. TPCODL against all losses from the acts or default of the said Associate in respect of compliance of the Local Sales Tax Laws, Local Laws, Labour Laws, Local Municipal Dues, Electricity dues etc.

NOW THE CONDITION, of the above written bond is as such that if the Associate during the period of this contract commits any default or fails to make payment of Contributions in respect of his employees to the Employees Provident Fund Organization, he shall indemnify the Principal Employer M/s. TPCODL from all and every loss and damage caused to them from any act, omissions or negligence of the said Associate in respect of compliances under the Employees Provident Fund and Miscellaneous Provisions Act, 1952.

IN WITNESS to the above written bond we have here to set our hands, with our free consent.

Dated

Signature

Place

Name

Designation (Company Seal)

Doc. Title	GENERAL CONDITIONS OF CONTRACT - COMPOSITE WORKS	
Rev. No	0	Page 42 of 104

ANNEXURE-F

**PROFORMA FOR APPLICATION FOR ISSUANCE OF CONSOLIDATED TDS
CERTIFICATE**

To be printed on the letterhead

To,

TP Central Odisha Distribution Limited,

Bhubaneswar

Sub: Application for issuance of Consolidated TDS Certificate for the FY _____

Dear Sir,

I / we hereby request / authorize you to issue me / us a consolidate TDS Certificate for the financial year _____ against tax deducted at source by you from my / our payments / bills during the said year from time to time under Chapter XVII – B of the Income Tax Act, 1961.

For and on behalf of

Signature

Name

Address

Contact No. (Land Line)

(Mobile)

PAN #

Assessing authority

ATTACH THE COPY OF PAN CARD

Doc. Title	GENERAL CONDITIONS OF CONTRACT - COMPOSITE WORKS	
Rev. No	0	Page 43 of 104

ANNEXURE - G

SERVICE LEVEL AGREEMENT

(To be adhered to by Business Associates (BAs) in TPCODL on Human Resource Issues)

1.0 The following shall be adhered to by the Business Associates during his / its association with TPCODL:

Shall Abide by Tata Core Values:

- a) **Integrity** – We must conduct our business fairly, with honesty and transparency. Everything we do must stand the test of public scrutiny.
- b) **Understanding** – We must be caring, show respect, compassion and humanity to our colleagues and customers and always work for the benefit of the communities we serve.
- c) **Excellence** – We must constantly strive to achieve the highest possible standards in our day to day work and in the quality of services we provide.
- d) **Unity** – We must work cohesively with our colleagues across the group and with our customers and partners to build strong relationships based on tolerance, understanding and mutual co-operation.
- e) **Responsibility** – We must continue to be responsible and sensitive to the communities and environments in which we work and always ensuring that what comes from the people; goes back to the people many times over.
- f) **Agility**- We must work in a speedy and responsive manner and be proactive and innovative in our approach.

2.0 The Business Associate / his manager / supervisor who is responsible for managing the project site / performance contract etc. in TPCODL would also ensure adherence of these values by his employees / persons deployed by him in connection with his works undertaken in TPCODL.

3.0 The Business Associates are required to:

- a) Support and respect the protection of human rights and make sure that they are not complicit in human right abuses.
- b) Respect freedom of association and effective recognition of the right to collective bargaining.
- c) Not to resort to any form of forced and compulsory labour.
- d) Shall ensure abolition of child labour in his area of work.
- e) There is no discrimination in respect of employment and occupation in respect of his employees.
- f) Support precautionary approach to environmental challenges.
- g) Promote greater environmental responsibility by himself and his employees in his areas of work.
- h) Deploy and defuse environmental friendly technologies while carrying out the works.
- i) Work against corruptions in all its form including extortion and bribery by himself and his employees.

4.0 The Business Associates are required to adhere to all applicable Labour Laws with special reference to the following:

Doc. Title	GENERAL CONDITIONS OF CONTRACT - COMPOSITE WORKS	
Rev. No	0	Page 44 of 104

- a) No person below the age of 18 years and no child labour will be engaged directly or indirectly for executing the work connected with the business of TPCODL.
- b) Minimum wages along with other statutory dues like PF, ESI, etc. as applicable to the workers shall be made within the prescribed period of 7th / 10th day of the following month.
- c) Deduction / deposit / record keeping and all other requirements under Employees PF Act 1952, Employees State Insurance Act 1948 and other applicable acts (if any) shall be adhered to.
- d) Only statutorily authorized deductions (if any) shall be made in accordance with the relevant statutes.
- e) All the provisions of Contract Labour (R&A) Act 1970 shall be complied with in respect of the workers engaged for TPCODL work. The work will be commenced only after completing necessary formalities for obtaining Labour License (if applicable).
- f) Necessary registers / records, filing of returns etc. shall be maintained for verification by Statutory / TPCODL authorities.
- g) Payment of wages shall be made only in presence of and with certification of authorized representative of TPCODL or shall be made in the form of cheque / bank transfer to the employee.
- h) During the period of contract, the Business Associate will arrange for deployment of his supervisor / manager for total supervision and control of the work and their manpower. All the activities related to their manpower e.g. attendance, leave, wage disbursement etc. will be done under the supervision & control of Business Associates, While adhering to the prescribed standard / norms of production / productivity & quality. During execution of the work, Business Associate shall engage only such qualified / skilled manpower as may be envisaged / required for ensuring level of production / service into the contract / work order.
- i) Clearances as follows shall be obtained from IR & Welfare Group:
 - i. Clearance for commencement (before start of the work).
 - ii. No Objection Certificate (after completion / before final settlement).
 - iii. Copies of PF / ESI Challans shall be deposited with IR & Welfare Group every month
- j) The Business Associate shall indemnify TPCODL from any liabilities under applicable Labour Statutes.
- k) The Business Associate shall ensure safety and health of his employees and shall also maintain hygienic working environment / condition in his area of work.
- l) The Business Associate and his employee shall abide by Laws of Land and shall not violate any applicable provisions.
- m) The Business Associate appreciates with and acquiesces to the right of TPCODL as principal employer to fulfil any of his legal obligations, if he fails to do so under applicable labour laws and deduct the same from his running bills / final payments / encashing security deposit / Bank Guarantee as the case may be. If there is any further shortfall TPCODL has the right to recover the same from the Business Associate.
- n) The Business Associate ensures that person employed by him adhere to the moral and legal conduct and shall not violate any standard conduct envisaged in the premise of

Doc. Title	GENERAL CONDITIONS OF CONTRACT - COMPOSITE WORKS	
Rev. No	0	Page 45 of 104

TPCODL by all such as, Transparency, Safety, Discipline, Integrity etc. The Business Associate or his employees should refrain from corrupt practices, giving or taking bribe in connection with any TPCODL business.

5.0 The 'Statutory Compliance Enforcement System' in TPCODL is detailed below for adherence by all concerned. Business Associate Cell (BA Cell) will be the process owner for implementation of the system with the help of concerned Engineer I/c or Officer I/c.

- a) Statutory Compliance being a professed value in TPCODL Code of Conduct, the concerned Engineer / Officer in charges are requested to adhere to the provisions and advise respective Business Associates in their domain to comply in letter and spirit.
- b) Immediately after issuance of letter of intent, the authorized representative of the Business Associate will report to BA Cell for completion of statutory requirements.
- c) Normally, the work will be started only after 'Clearance for Commencement of Work (CCW)' is issued by BA Cell to the Business associate. However in exceptional exigencies in engineer I/c / Officer I/c may direct the Business Associate to start the work and inform BA Cell about the same. Statutory requirements in this case may be completed in parallel.
- d) First monthly bill will be released only after producing CCW to the finance department. Similarly closure of work and final settlement will be affected after issuance of no objection certificate from BA Cell group.

6.0 Requirements for 'Clearance for Commencement of Work' (CCW):

- a) Submission of filled up Form 'A' for database (Annexure-1).
- b) Copy of PF Code allocation letter.
- c) Copy of ESI Code allocation letter.
- d) Submission of duly filled up Form IV CL(R&A) act (In case more than or equals to 20 workers during the period of contract).
- e) Submission of duly filled up Form VI A (Notice of Commencement).
- f) Copy of insurance cover note under WC Act 1923 (if applicable).
- g) Copy of Contract Agreement.
- h) Copy of indemnity bond (if applicable).
- i) Affidavit with regard to payment of wages through cheque / bank transfer only.

7.0 Requirements during execution of work:

- a) Copy of receipt of application for license / license (if applicable).
- b) Copy of PF Challan (latest by 26th day of every Month).
- c) Copy of ESI Challan (latest by 26th day of every Month).
- d) Copy of Wage disbursement sheet / Bank statement.
- e) Filing / Maintenance of all statutory registers / reports / returns for inspection by Statutory/TPCODL authorities.
- f) Certification of wage disbursement by authorized representative of TPCODL.
- g) Copy of 'Labour Welfare Fund' deposit certificate / Challan.
- h) Insuring safe working practices at the work place.

8.0 Requirements for 'No Objection Certificate' (NOC) for closure of work:

- a) Submission of duly filled up Form VI A (Notice of Completion).
- b) Copy of Half yearly / Annual return for ESI / PF / CL(R&A).

Doc. Title	GENERAL CONDITIONS OF CONTRACT - COMPOSITE WORKS	
Rev. No	0	Page 46 of 104

- c) Consolidated copy of wage sheet of last month indicating full & final settlement of all dues like retrenchment benefit, bonus, leave encashment etc. Copy of individual declaration by employees in Form X regarding termination of employment.
- d) Confirmation certificate regarding filling up of form for transfer / withdrawal of PF by the concerned workers.

In case any of the above are deviated / not complied with the Letter of Award/Order shall be liable to be withdrawn / cancelled.

Enclosure:

- 1) Form A
- 2) Form X
- 3) Form XI
- 4) Form VI A
- 5) Form XXIV

GENERAL CONDITIONS OF CONTRACT

Doc. Title	GENERAL CONDITIONS OF CONTRACT - COMPOSITE WORKS	
Rev. No	0	Page 47 of 104

FORM (A)

[To be submitted by the Business Associate to the Principal Employer within a week from LoA issuance]

A. Details of the Agency

1. Name of Agency :
2. Nature of work :
3. Local Address with Ph.No. :
(With Father's name) :
4. Permanent Address (Full) :
5. PF code no. & Place :
6. ESI Code no. & Place :
7. Name and address of :
Sub-contractor (if any)

B. Details of Work

8. Name of work (as specified in LOI/LOA) :
9. LOI/LOA Nos. & Dates :
10. Period of contract (Specify Dates) :
[Including Extension period, if any] :
11. Work Area [Department / Location] :
12. Name / Cell no. of Officer I/c :
13. Maximum No. of workers and staff to be engaged on any day during the year.
 - Supervisory Staff :
 - Workers :
14. Do you have any other contract in TPCODL : Yes/No
If yes, furnish details:

15. Details of Workmen's compensation Policy, if applicable

Name of Insurance Company
Policy No Number of persons covered
 Period of coverage: From To

If no, I hereby undertake the liability arising out of Workmen's Compensation Act and Rules made there under.

C. Details of workers to be engaged

No. of Workers

S. No.	Unskilled*	Semi-skilled*	Skilled*	Clerical / Supervisory

*** Number to be indicated**

I/We shall fulfill all obligations arising from and under all relevant law in force from time to time. I/We undertake to keep the TPCODL indemnified against any loss or liability arising out of failure of my / our abiding the relevant laws.

The name of my / our representatives is to enter the TPCODL Premises on my behalf.

Date:

**(Signature of the Business Associate
 or his Authorized Representative)**

This Business Associate is / will be engaged in TPCODL.

**(Signature and seal of
 Officer I/c of the Work)**

Doc. Title	GENERAL CONDITIONS OF CONTRACT - COMPOSITE WORKS	
Rev. No	0	Page 49 of 104

Form X

Undertaking

I _____ hereby undertake that all the dues in respect of my employment with M/s _____ for the period of _____ to _____ have been settled and final payments including retrenchment benefit have been made to me in full.

(_____)

Date:

GENERAL CONDITIONS OF CONTRACT

Doc. Title	GENERAL CONDITIONS OF CONTRACT - COMPOSITE WORKS	
Rev. No	0	Page 50 of 104

Form XI

Undertaking

With reference to the contract job awarded by M/s TP Central Odisha Distribution Limited to M/s _____ vide work order No. _____ dated _____

I _____ on behalf of

M/s _____ hereby undertake:

1. that the dues in respect of the workmen/ employee(s) engaged by us for the said contract, payable as per the provisions of relevant statute pertaining to

- i. wages/ salary
- ii. PF & ESI, Bhubaneswar Labour Fund
- iii. All other statutory obligation

has been paid /settled in full and no amount/ compliance is due/ pending.

2. That in case any dispute / claim is raised by the concerned workers i.r.o. any dues / payments, M/s _____ will settle the same on it's own and such liability will be borne by M/s _____

3. That M/s _____ hereby indemnify M/s TPCODL from any future liability i.r.o. any statutory obligation in respect of said contract.

Date:

()
Authorized Signatory

For M/s _____

Doc. Title	GENERAL CONDITIONS OF CONTRACT - COMPOSITE WORKS	
Rev. No	0	Page 51 of 104

FORM- VI A

Notice for Commencement /Completion of contract work

I/We, Sh. / M/s _____ (Name and Address of the Contractor) hereby intimate that the contract work _____ (name of work) in establishment of the _____ (name and address of the Principal Employer) for _____ which License No. _____ dated _____ has been issued to me/us by the Licensing Officer _____ (name of the Headquarters), has been commenced / completed with effect from _____ date / on date.

Signature of Contractor

With Office Seal

The Inspector

FORM XXIV

[See Rule 82(1)]

Return to be sent by the Contractor to the licensing Officer (in duplicate)

Half -Yearly Ending _____

1. Name and address of the Contractor
2. Name and address of the Establishment
3. Name and address of the Principal Employer
4. Duration of Contract: From _____ to _____
5. No. of days during the half year on which
 - (a) the establishment of the principal employer had worked
 - (b) the contractor's establishment had worked

6. Maximum No. of contract labour employed on any day during the half –year:

Men	Women	Children	Total

7.
 - (i) Daily hours of work and spread over
 - (ii) (a) whether weekly holiday observed and on what day
(b) if so, whether it was paid for
 - (iii) No. of man – hours of overtime worked

8. No. of man days worked by

Men	Women	Children	Total

9. Amount of wages paid

Men	Women	Children	Total

10. Amount of deductions from wages, if any

Men	Women	Children	Total

Whether the following have been provided –

- (i) Canteen : _____
- (ii) Rest rooms : _____

Doc. Title	GENERAL CONDITIONS OF CONTRACT - COMPOSITE WORKS	
Rev. No	0	Page 53 of 104

(iii) Drinking water : _____

(iv) Crèches : _____

(v) First Aid : _____

Signature of contractor

Place _____

Date _____

GENERAL CONDITIONS OF CONTRACT

Doc. Title	GENERAL CONDITIONS OF CONTRACT - COMPOSITE WORKS	
Rev. No	0	Page 54 of 104

ANNEXURE – H

UNDERTAKING FOR COMPETENCE OF WORKMEN

Name of Associate :

Tender No. :

Item :

With reference to the tender mentioned above, I/We _____, hereby undertake that the workmen/ employee(s) engaged by M/s _____ for the job against said tender shall be competent in all respect, commensurate to the nature of job.

Date:

()

Authorized Signatory

For M/s

Seal

GENERAL CONDITIONS OF CONTRACT

Doc. Title	GENERAL CONDITIONS OF CONTRACT - COMPOSITE WORKS	
Rev. No	0	Page 55 of 104

ANNEXURE-I

BUSINESS ASSOCIATE FEEDBACK FORM

With an objective to improve our internal processes and systems, and serve you better, we solicit your valuable feedback & suggestions. It is estimated that it will take about 10 minutes to complete this survey. We assure you that your feedback shall be kept confidential. Please send the duly filled feedback form in the "TPCODL addressed - attached envelop"

You are associated with us as

OEMs Service Contractor Material Suppliers Material & Manpower Supplier

You are associated with us for

Less than 1 year More than 1 year but less than 3 years More than 3 years

Your office is located at

Bhubaneswar Within 200 kms from Bhubaneswar More than 200 kms from Bhubaneswar

Your nearly turnover with TPCODL

Less than 25 Lacs 25 Lacs to 1 Crore More than 1 Cr.

Additional information

Your Name	
Your Designation	
Your Organization	
Contact Nos.	
Email	

We once again thank you for your participation in this survey. Please spare 10 minutes to give your feedback on following pages (Section A to E)

SECTION - A

(Please ✓ mark in the relevant box and give your remarks / suggestions / information for our improvement.).

S. No.	Parameters	1	2	3	4	5	Remarks/ Suggestion
		Do Not Agree	Slightly in Agreement	In Fair Agreement	Mostly in Agreement	Fully Agree	
1	You receive all relevant queries / tenders from us in timely manner.						
2	We provide you enough lead time to respond to our queries / tenders.						
3	We provide you adequate support (drawings, documents, clarifications, briefing etc.) to enable you meet our requirements.						
4	All following elements of our contract / purchase order are rational :						
4.1	Scope of Work						
4.2	Delivery / Execution Schedule						
4.3	Payment Terms						
4.4	Liquidated Damages						
4.5	Performance Guarantee						
5	Our purchase orders / contracts are simple, specific & easy to understand						
6	TPCODL demonstrate willingness to be flexible in administration of Contract / Purchase Order						
7	We provide timely responses / clarifications to your queries						
8	TPCODL representative you interact / coordinate with is adequately empowered to support you in meeting contractual obligations						
9	TPCODL provide you all necessary infrastructure support for timely and quality completion of work (including AMC)						
10	TPCODL Engineer-in-Charge timely certifies the jobs executed/ material supplied						

S. No.	Parameters	1	2	3	4	5	Remarks/ Suggestion
		Do Not Agree	Slightly in Agreement	In Fair Agreement	Mostly in Agreement	Fully Agree	
11	TPCODL Engineer-in-Charge efficiently supervises the job execution for timely completion of job						
12	BIRD (Bill Inward Receipt Desk) initiative has improved payment disbursement process						
13	Our approach for Inspection and Quality Assurance effective to expedite project completion?						
14	TPCODL never defaults on contractual terms						
15	In TPCODL Contracts closure is done within set time limit						
16	Our material receiving procedures are well defined and efficiently deployed to reduce mutual inconvenience						
17	Bank Guarantees are released in time bound manner						
18	Our processes related to payment / account settlement are effective.						
19	You get payments on time						
20	TPCODL Employees follow Ethical behaviour						

SECTION - B

(Please rate the following parameters on a scale of 1 to 5, where 1 - Minimum; 5 - Maximum)

SN	Parameters	1	2	3	4	5	Remarks/ Suggestion
1	How do you rate courtesy/ empathy/ attitude level and warmth of TPCODL employees you interact with from following team?						
1.1	Project Engineering						
1.2	Division / Sub-Division						
1.3	Projects/HOG						
1.4	Inspection & Quality Assurance						
1.5	Stores						
1.6	Metering & Billing						
1.7	Accounts / Finance						
1.8	Administration						
1.9	IT & Automation						
2	How would you rate TPCODL in comparison to your other clients in terms of fairness of treatment and transparency with its Business Associates?						
3	How would you rate TPCODL in comparison to your other clients in terms of processes and systems to manage partnership with its Business Associates						
4	How would you rate TPCODL in comparison to your other clients in terms of building long term & mutually relationship with its Business Associates						

SECTION-C

Please ✓ mark in the relevant box and give your remarks / suggestions / information for our improvement.

SNo	Parameters	Certainly NO	Probably NO	Probably YES	Certainly YES	Remarks/ Suggestion
1	Based on your experience with TPCODL, would you like to continue your relationship with TPCODL?					
2	If someone asks you about TPCODL, would you talk "positively" about TPCODL?					
3	Would you refer TPCODL name to others in your community, fraternity and society as a professional & dynamic organization?					

SECTION - D

If we ask you to rate us on a scale of 1 to 10, how will you rate TPCODL, that truly represents your overall satisfaction with us (please tick appropriate box) -

1	2	3	4	5	6	7	8	9	10
---	---	---	---	---	---	---	---	---	----

Doc. Title	GENERAL CONDITIONS OF CONTRACT - COMPOSITE WORKS	
Rev. No	0	Page 60 of 104

SECTION – E

Please ✓ mark in the relevant box and give your remarks / suggestions / information for our improvement.

Please spare your thoughts for TPCODL's improvement in particular areas of weaknesses, particularly relating to some great practices, attitudes that you have seen elsewhere in Indian and International Organizations, which you recommend TPCODL to adopt. Please give your valuable salient recommendations.

Please spare your thoughts for TPCODL's improvement in particular areas of major concerns for you. We also welcome your suggestions to adopt any best practices, altitudes that you have observed / experienced elsewhere in Indian/ International organization.

Recommendation	<i>Please tick (✓) your top 5 expectations out of the following 10 points listed below -</i>	
(Please list down improvement you expect from TPCODL)	<i>Timely payment</i>	
1	<i>Flexibility in Contracts/PO</i>	
	<i>Clarity in PO,s & Contracts</i>	
2	<i>Timely response to quarries</i>	
	<i>Timely certification of works executed</i>	
3	<i>Clarity in Specs, drawings, other docs etc.</i>	
	<i>Adequate information provided on website for tender notification, parties qualified etc.</i>	
4	<i>Timely receipt of material at site for execution</i>	
	<i>Performance Guarantee/EMD released in time</i>	
5	<i>Inspection & quality assurance support for timely job completion</i>	

We thank you for your time and courtesy!!

Doc. Title	GENERAL CONDITIONS OF CONTRACT - COMPOSITE WORKS	
Rev. No	0	Page 61 of 104

ANNEXURE-J

ACCEPTANCE FORM FOR PARTICIPATION IN REVERSE AUCTION EVENT

(To be signed and stamped by the bidder prior to participation in the auction event)

In a bid to make our entire procurement process more fair and transparent, TPCODL intends to use the reverse auctions through SAP-SRM tool as an integral part of the entire tendering process. All the bidders who are found as technically qualified based on the tender requirements shall be eligible to participate in the reverse auction event.

The following terms and conditions are deemed as accepted by the bidder on participation in the bid event:

1. TPCODL shall provide the user id and password to the authorized representative of the bidder. *(Authorization Letter in lieu of the same shall be submitted along with the signed and stamped Acceptance Form).*
2. TPCODL will make every effort to make the bid process transparent. However, the award decision by TPCODL would be final and binding on the supplier.
3. The bidder agrees to non-disclosure of trade information regarding the purchase, identity of TPCODL, bid process, bid technology, bid documentation and bid details.
4. The bidder is advised to understand the auto bid process to safeguard themselves against any possibility of non-participation in the auction event.
5. In case of bidding through Internet medium, bidders are further advised to ensure availability of the entire infrastructure as required at their end to participate in the auction event. Inability to bid due to telephone line glitch, internet response issues, software or hardware hangs, power failure or any other reason shall not be the responsibility of TPCODL.
6. In case of intranet medium, TPCODL shall provide the infrastructure to bidders. Further, TPCODL has sole discretion to extend or restart the auction event in case of any glitches in infrastructure observed which has restricted the bidders to submit the bids to ensure fair & transparent competitive bidding. In case an auction event is restarted, the best bid as already available in the system shall become the start price for the new auction.
7. In case the bidder fails to participate in the auction event due any reason whatsoever, it shall be presumed that the bidder has no further discounts to offer and the initial bid as submitted by the bidder as a part of the tender shall be considered as the bidder's final no regret offer. Any offline price bids received from a bidder in lieu of non-participation in the auction event shall be outrightly rejected by TPCODL.
8. The bidder shall be prepared with competitive price quotes on the day of the bidding event.
9. The prices as quoted by the bidder during the auction event shall be inclusive of all the applicable taxes, duties and levies and shall be FOR at TPCODL site.
10. The prices submitted by a bidder during the auction event shall be binding on the bidder.
11. No requests for time extension of the auction event shall be considered by TPCODL.
12. The original price bids of the bidders shall be reduced on pro-rata basis against each line item based on the final all inclusive prices offered during conclusion of the auction event for arriving at Contract amount.

Signature & Seal of the Bidder

Doc. Title	GENERAL CONDITIONS OF CONTRACT - COMPOSITE WORKS	
Rev. No	0	Page 63 of 104

send payment information)

Name of the Authorized Signatory :

Contact Person's Name :

Official Correspondence Address :

We confirm that we will bear the charges, if any, levied by our bank for the credit of NEFT/RTGS amounts in our account. Any change in above furnished information shall be informed to TPCODL well in time at our own. Further, we kept TPCODL indemnified for any loss incurred due to wrong furnishing of above information.

Thanking you,

For _____

(Authorized Signatory)

(Signature with Rubber Stamp)

Certification from Bank:

We confirm that we are enabled for receiving NEFT/RTGS credits and we further confirm that the account number (specify Bank a/c no.) of (Please mention here name of the account holder), the signature of the authorized signatory and the MICR and IFSC Code of our branch mentioned above are correct.

This also is certified that the above information is correct as per Bank record

(Manager's/ Officers Signature under Bank Stamp)

ANNEXURE-L
CONTRACTOR SAFETY MANAGEMENT SYSTEM

1. OBJECTIVE

The objective of the Contractor Safety Management System is to lay down clear guidelines for all Business Associates (including their associates, staff and agents) which would facilitate them to observe all statutory rules and regulations, comply with applicable standards of Central Electricity Authority (Measures relating to safety and electric supply) Regulations, 2010 & (safety requirements for construction, operation and maintenance of electrical plants and electric lines) Regulations, 2011, TPCODL Safety Manual and Guidelines and thus, ensure creation of safe working environment for all stakeholders of our network.

2. SCOPE

All contracts (minor and major) will be subject to the provisions of this document.

Minor Contracts: Contracts which satisfy all the criteria listed under the head "Minor Contracts".

Major Contracts: Contracts which satisfy any two or more criteria listed under the head "Major Contracts"

Criteria	Minor Contracts	Major Contracts
Value of Contract	< Rs. 1500000/- (less than Rs. Fifteen Lac)	>= Rs. 1500000/- (Equal or more than Rs. Fifteen Lac)
Period	Period less than 1 year	Any period
Working on energized electrical equipment	No	Yes
Working on height (above 1.8 Mtrs from ground)	No	Yes
Work involving construction activity	No	Yes
Working with hazardous goods or chemicals	No	Yes
Work involving danger to general public	No	Yes

Note: Exceptions for major and minor contract are – in house software development, supply of material or equipment but no direct or indirect installation of the same material, administration contracts (courier, water supply, printing, security, transport, etc.), minor civil work like plastering at ground level or flooring, etc. The facility management (housekeeping) contract will always be treated as a minor contract.

Doc. Title	GENERAL CONDITIONS OF CONTRACT - COMPOSITE WORKS	
Rev. No	0	Page 65 of 104

3. INFORMATION REQUIRED AT TIME OF VENDOR REGISTRATION OR BEFORE COMMENCEMENT OF CONTRACT

- 3.1 Business Associate is required to fill the Safety Management System Questionnaire as per *annexure 1* and submit along with the vendor registration process / bid / tender document. The filled questionnaire will be scrutinized by Engineer In-charge / indenting group and recommend suitability of the BA with respect to safety requirements. The fulfilment of statutory requirements for vendor registration pertaining to labour laws etc. shall be done by BA Cell on being referred to it.
- 3.2 Business Associate is required to take suitable risk control measures mentioned against the identified Hazards and Risk document provided for all contracts as per *annexure 2*. The primary objective of this is to evaluate the understanding of the BA towards risk mitigation and employment of safe work procedures. BA is required to conduct the Hazard identification and Risk Assessment study as per the procedure and deploy more or other measures if deemed necessary.
- 3.3 Business Associate shall comply with **Statutory Requirements related to Safety and Occupational Health** and submit the "Safety Undertaking" as per *annexure 4*.

4. GENERAL SAFETY CONDITIONS REQUIRED TO BE FULFILLED BY BUSINESS ASSOCIATES

The requirements of the contractor safety management system applicable to the minor or major contracts related to various groups are as following –

- 4.1 Maintenance of Distribution Network – *Annexure 3.1*
- 4.2 Distribution Projects – *Annexure 3.2*
- 4.3 EHV Projects – *Annexure 3.3*
- 4.4 Maintenance of Sub transmission network – *Annexure 3.4*
- 4.5 Civil / Generation Projects – *Annexure 3.5*
- 4.6 Meter Management Group (MMG), Revenue Recovery Group (RRG), Energy Auditing Group, AML, MRG, etc. – *Annex3.6*
- 4.7 Maintenance and Operation of Street Light. – *Annexure 3.7*

1. *Please note that hydra cranes used by any dept should be ACE Model No. FX 150 ACE SX 150, Escorts Model No. TRX 1550 or contemporary. Use of old generation hydra cranes like ACE 14XW or ACE 12 XW, etc are prohibited.*

(Details as per Annexure attached)

Note: *For minor contracts, the BA shall assign the duties of Safety Representative to the Work Supervisor. Work Supervisor will deliver all duties and responsibilities of Safety Supervisor as detailed in this document.*

The Business Associate (BA) having major contract will appointing Safety supervisor, engineer / manager for the TPCODL work. The BA shall make all necessary arrangements for getting their workforce safety trained and competency checked from the concerned official of TPCODL before deployment in the field. BA Cell shall recommend the suitability after competency checked by Engineer In-charge and SAFETY group (or his representative) of TPCODL. After getting the clearance from concerned official, BA cell and receiving temporary I-card issued by TPCODL, Business Associate shall commence the working.

Safety Representative of Business Associates will formally become the nodal point for safety concerns for TPCODL. **BA shall not frequently transfer or terminate the services of any of the safety representatives appointed for TPCODL work site. BA needs to ensure**

Doc. Title	GENERAL CONDITIONS OF CONTRACT - COMPOSITE WORKS	
Rev. No	0	Page 66 of 104

that Safety representative is available at all points of time; failing which the work being carried out in the interim (period when Safety representative is not available) shall be treated as working under improper supervision and due penal provisions shall be initiated against the BA. BA will be required to provide all applicable infrastructure and power to ensure smooth working of the safety representative to maintain a sound safety management system. **In all contracts safety representative will not be assigned any other activity at site apart from the works related to safety management. The duties are detailed in clause 5.5 of this document.** TPCODL will be auditing the facilities provided to the BA's safety team time to time.

The Safety Representative of the BA shall be required to meet and follow the instructions of the Engineer In-charge and SAFETY Group of TPCODL. He shall be responsible for providing the MIS and/or any other relevant information, as and when desired, within the stipulated time frame as per the requirements of TPCODL. Any non-conformance to safety will lead to the negative marking or issue of safety violation challan/ tokens which shall affect the monthly evaluation and performance of BA.

All contracts where BA has to depute vehicle for their staff and equipment to move from one location to other, the BA shall ensure that vehicle complies all required statutory clearances and requirement as per The Motor Vehicle Act, 1988 as well as TPCODL Road Safety Policy and are in good & safe state of working.

5. QUALIFICATION AND EXPERIENCE OF THE SAFETY AND SITE PERSONNEL

Qualification and experience required for the safety and site personnel are as following:

5.1 Safety Supervisor: It is mandatory that educational qualification of safety supervisor be ITI (of relevant trade) / Diploma (Any branch of engineering) and he has a working experience on electrical system / relevant field of work at least 5 yrs for ITI and 3 years for Diploma holder. Having formal experience of the safety systems will be an added advantage

5.2 Safety Engineer: It is mandatory that educational qualification of safety engineer be at least Diploma (relevant branch) and he has working experience on electrical system of at least 3 yrs. Having the formal experience of the safety systems will be an added advantage.

5.3 Safety Manager: The educational qualification of safety manager should be graduate engineer with working experience on electrical system / network of at least 3 yrs. OR Diploma in Industrial Safety with working experience of 05 years including at least 02 years on electrical network.

However, clause 5.1, 5.2 and 5.3 are not applicable for minor contracts. In such cases, BA shall assign the duties of Safety Representative to the Work Supervisor. Work Supervisor will deliver required duties of Safety Representative (as per clause 5.5) in addition to other duties without diluting the importance of safety.

5.4 Site Skilled Personnel: For all responsibility related to site activities and operations, the BA shall employ only qualified and skilled persons and shall comply the provisions of section 19 & 29 of Central Electricity Authority (Measures relating to safety and electric supply) Regulations, 2010. Persons holding valid approvals only by any Government approved agency or a competency assessment panel or a team set up by TPCODL

Doc. Title	GENERAL CONDITIONS OF CONTRACT - COMPOSITE WORKS	
Rev. No	0	Page 67 of 104

shall be allowed to perform the High Risk / High Hazard activities (refer page 1). The skill / qualification required for the electrician and electrical supervisor are given in *annexure 5*. The contracts related to maintenance of Distribution Network, Distribution Projects, EHV Projects, maintenance of Sub-Transmission Network, MMG & EAG, maintenance and operation of street lights, shall preferably have at least 20 per cent of ITI qualified electricians in the first year of the contract. This figure shall preferably be incremented by 15 per cent every subsequent year.

Note: For the competency assessment may please refer the work instructions. An employee shall have to necessarily undergo the competency assessment check once in every eighteen months.

5.5 Requirements from the Safety Representative(s) of the Business Associate:

- 5.5.1 Safety training of 2 hrs/employee/month and one day of safety induction training to all new employees joining the BA will be conducted by the BA as per Safety training modules of TPCODL.
- 5.5.2 Safety Talk / tool box talk before start of shift to BA employees.
- 5.5.3 Ensuring the availability & proper usage of the standard safety equipment (PPE)
- 5.5.4 Periodic inspection of PPE to ensure their serviceability and maintaining the 10% buffer stock of standard PPEs.
- 5.5.5 Ensuring the adherence to standard operating procedures of TPCODL as mentioned in TPCODL Safety standard and O & M and concerned function's manual.
- 5.5.6 Safety inspections / audits as per the process of TPCODL
- 5.5.7 Working in close coordination SAFETY Group of TPCODL.
- 5.5.8 Reporting of unsafe acts, unsafe conditions, near miss, incident or accident to Engineer In-Charge and SAFETY Group of TPCODL immediately after its occurrence.
- 5.5.9 Regular HIRA at site and comply the control measures as stated in the detailed HIRA as per the *annexure 2*. Also deployment of JSA based checklist shall be ensured.
- 5.5.10 Ensuring compliance with safety and other laws as may be applicable and providing for safety assurance.

5.6 Training and Syllabus: The BA shall not deploy any person at work place / site or send newly recruited personnel directly to concerned official for competency assessment without Safety Induction Training.

5.6.1 All new BA employees have to necessarily undergo one and half days Safety training and Competency assessment at training centre of BA cell. This training will be conducted once in a week. After the completion of Safety training & Competency assessment I-card will be issued to all competent BA employees

5.6.2 BA is expected to initially train and judge the capability of the workman at his own end before further recommending the workmen for Competency assessment. If any BA workman sent for competency assessment. In case any BA workman fails in the Competency test at concerned official, it will be deemed that BA has not imparted sufficient training at his end and actual cost of training ₹ 7500/ BA employee/ failed attempt will be recovered.

5.6.3 The workers who have imparted Safety Training and issued I-Cards of TPCODL, are not deployed at TPCODL worksites/ voluntarily left the job by workers/ used somewhere else other than TPCODL by the BA, in that case Management reserves the rights to intervene and recover the actual cost of training i.e. ₹ 7500/BA employee. (*Exempted for attrition rate of BA workers less than or equal to 10% of total workforce deployed at TPCODL*)

Doc. Title	GENERAL CONDITIONS OF CONTRACT - COMPOSITE WORKS	
Rev. No	0	Page 68 of 104

5.7 It is desired that Safety representative of the BA to impart the general safety training to each employee of duration 2 hrs per month. The training will be organized at BA level and the record to be sent to engineer in-charge and SAFETY group of TPCODL every month. Please refer schedule and syllabus in *annexure 6*.

List of Personal Protective Equipment (PPE) and Maintenance schedule: BA shall commence the project or any work only when the required PPE are made available to the team of employees involved in the work. Each PPE of BA shall be checked / inspected by the safety representative / supervisor at zone before the work start or as prescribed in the list. Safety representative shall regularly check the healthiness of each PPE allocated to lineman. Suitable record shall be maintained at zone. Defective PPE shall be immediately replaced or within 24 hours by the BA. In no case linemen or any other official of BA may be allowed to work with defective PPE. It is preferred that BA ensures minimum stock of each PPE at zone for immediate replacement with defective one. The PPE shall be IS / BS / CE marked and exactly as per the standard or specification mentioned in the *annexure 7*. Working without PPE / non-standard PPE shall be treated as safety violation and penalty as stated in section 6.0 of this document. If TPCODL finds that BA has not provided the adequate / appropriate PPE to their staff, TPCODL reserves the rights to stop the work and call the BA to provide appropriate PPEs at the risk. If the BA fails to provide the required PPEs at the risk then the same shall be provided by TPCODL at the actual cost of the PPE. The amount shall be charged to BA and same shall be first recovered from the current bill of BA or any future payment to be made to BA. In the event of any balance amount still left for recovery, the same shall be adjusted against retention amount or by invoking bank guarantee submitted by BA.

5.8 Safety Audit / Inspection & HIRA: The BA shall get the required safety inspection / audit conducted by his technical team comprising of safety representative as per the *annexure 8*. The safety representative will be required to conduct the HIRA (Hazard Identification and Risk Assessment) as per *annexure 2* of the process and work undertaken at least two times in a year or every time if a new process / activity / machine is introduced or whenever an accident take place. The risk identified to be addressed suitably with –

- Engineering Control
- Management Control, and
- Personal Protective Equipment.

The safety representative of BA shall inform and educate for the identified risk and hazard control methods to employees, supervisor and engineer as well as the engineer in-charge and SAFETY group of TPCODL.

5.9 Safety Performance and Safety MIS: The BA shall maintain good practice of safety all through the contract duration. Safety shall always be of paramount importance during the contract period. Safety performance will be monitored on yearly basis throughout the period and no relaxation will be given for bad performance. BA with good track record and excellent performance will be rewarded suitably as per clause 6.0 of this document. The BA has to provide monthly “Performance Report – Safety” to engineer in-charge and SAFETY group TPCODL this shall be part of monthly bill along with training details. Performa of the report is enclosed as *annexure 9*.

5.10 Pre – Employment Medical Check-up and Fitness of employees engaged for the critical works: The BA shall submit the health fitness certificate for all those workers involved in climbing the pole or working at height for following diseases:

5.10.2 Epilepsy

Doc. Title	GENERAL CONDITIONS OF CONTRACT - COMPOSITE WORKS	
Rev. No	0	Page 69 of 104

- 5.10.3 Colour blindness
- 5.10.4 Deafness
- 5.10.5 Vertigo & height phobia

Every year BA will give an undertaking stating that all the employees are fit to work and have not developed aforesaid diseases. The Record of such medical check-ups shall be submitted to BA Cell before issue of temporary identity card. The records shall be maintained at BA Cell. All such medical check-ups shall be repeated once in a year for all workers involved in climbing the pole or working on electrical network.

6. REWARD AND PUNITIVE MEASURES

6.1 To support the enforcement of good SHE & DM practices by the Business Associate and to eliminate repeated or continuing safety violations, use of appropriate reward and punitive measures shall be made. Each unsafe act or violation of the safety guidelines as described in the Safety Manual of the TPCODL will be audit criteria of this system. Broadly the measures identified are following:

- 6.1.1 Working without PPE/ Safety Gadgets
- 6.1.2 Working without proper tools and tackles, barricading, Poor condition of Crane / Hydra / Vehicle, using without certification / Licence, Incompetent driver/ Helper
- 6.1.3 Working without creation of effective safety zone
- 6.1.4 Improper Supervision at worksite, Lineman/ Supervisor working without competency
- 6.1.5 Working without adherence to PTW process or authorization/ not adherence to SOPs / W.I. of TPCODL.
- 6.1.6 Improper Working at height equal to or above 1.8 mtrs without taking proper fall protection measures/ Poor condition of Ladder

6.2 Measures of Reward and Punitive Measures

The Engineer In-Charge, NSO, SC, ASOs, CSI / SIs and SHE &DM group will conduct the surprise audits of the work / project and if any non-conformance is found the same will be booked and entered in the format "Safety Violation Record" *annexure 10*. The flow of the information is given below:

Safety Violation Escalation & Monitoring process	
Action	Responsibility
Safety Violation form has been filled and counter foil sent to SAFETY team for information. The main form is to be given to BA supervisor / Engineer in-charge. <i>(Automatically generated if Site audit done through Mobile App.)</i>	Engineer In-charge/ NSO / SC / SAFETY Group /CSI/ ASO/ Any authorised TPCODL official.
↓	
Entry of the violation in the master record and sending the information to concerned Manager, HoG, HoD, Head and Chief (O &S). <i>(Automatically generated if Site audit done through Mobile App.)</i>	SAFETY Group
↓	
Forwarding the information Centralized Account Payable (CAPS) for amount deduction from the current bill of the BA,	Engineer In-charge

<i>if any.</i>	
↓	
HoG (Safety – II) & HoG (Safety & Quality – Commercial) and CAPS to generate the MIS of the violations and the amount deducted.	SAFETY Group
↓	
The pool of the amount generated after the deduction to be utilized in safety welfare of BA employees.	SAFETY Group with approval of CFO/Chief (O & S) /CEO&MD

The safety violations have been rated from 1 to 5 (figure 6.3) as per the gravity of the violation. If the same violation is repeated it may escalate into a higher penalty. If a particular Business Associate employee violates safety norms three times, he shall not be allowed to work in TPCODL for a period of one year from the date of the 3rd violation.

6.3 Safety Violation Escalation Matrix

6.3.1

Consequence of Safety Violation Observed (Not related to Incident/ Accident)		Violation				Subsequent Violations
S.No.	Safety Violation	1st	2nd	3rd	4th	
1	Working without PPE (Helmet/Gloves/Safety Harness/ Safety Shoes etc.)	A	B	C	D	Will attract the same penalty as applicable in the 4th violation.
2	Improper Working at Height	A	B	C	D	
3	Working without proper tools and tackles	A	B	C	D	
4	Poor condition of Crane/Hydra/ Vehicle/Incompetent driver/ Helper	A	B	C	D	
5	Violation of SOP/ WI	B	C	D	E	
6	Working without adherence to PTW process or authorization/ Safety Zone	C	D	E		
Legend	Action to be taken	Responsibility	Penalty Amount (in Rs.)		The number of violations are to be calculated cumulatively over the contract period and not on monthly basis.	
A	Warning letter	Engineer Incharge	Nil			
B	Levy of Penalty	Engineer Incharge	2,000			
C	Memo to BA & Levy of Penalty	Head of Group	4,000			
D	Memo to BA & Levy of Penalty	Head of Department	10,000			
E	Memo to BA, Levy of Penalty and termination of Contract	Head of Department	1,00,000			

Figure 6.3 (1a)-Penalty Matrix for Safety violation (Applicable for Minor Contracts)

Consequence of Safety Violation Observed (Not related to Incident/ Accident)		Violation				Subsequent Violations
S.No.	Safety Violation	1st	2nd	3rd	4th	
1	Working without PPE (Helmet/Gloves/Safety Harness/ Safety Shoes etc.)	B	C	D	D	Will attract the same penalty as applicable in the 4th violation.
2	Improper Working at Height	B	C	D	D	
3	Working without proper tools and tackles	A	B	C	D	
4	Poor condition of Crane/Hydra/ Vehicle/Incompetent driver/ Helper	B	C	D	E	
5	Violation of SOP/ WI	C	D	E		
6	Working without adherence to PTW process or authorization/ Safety Zone	C	D	E		
Legend	Action to be taken	Responsibility	Penalty Amount (in Rs.)		The number of violations are to be calculated cumulatively over the contract period and not on monthly basis.	
A	Levy of Penalty	Engineer Incharge	5,000			
B	Memo to BA & Levy of Penalty	Engineer Incharge	10,000			
C	Memo to BA & Levy of Penalty	Head of Group	25,000			
D	Memo to BA & Levy of Penalty	Head of Department	50,000			
E	Memo to BA, Levy of Penalty and termination of Contract	Head of Department	1,00,000			

Figure 6.3 (1b)-Penalty Matrix for Safety violation (Applicable for Major Contracts)

Once the BA reaches the “BLACK” (color – “5”) category, i.e. highest level of safety violation, “Termination” notice to BA will be issued from the office of the Head of Department (equivalent to GM/ Sr. GM level) and further, *if required*, continuation / extension of contract will only be initiated by Functional Chief / Head of the department (equivalent to Sr. GM / Chief level) and approved by CEO & MD. Till the extension, the contract will remain suspended.

TPCODL encourages the reportage of the safety violation during the contract work by BA. Any TPCODL employee can register a safety violation against the BA in the “Safety Violation Form” *annexure 10*. Initially the observer has to fill the form and handover the counterfoil (lower portion) of the document to the supervisor of the BA, inform the site engineer of TPCODL and send the top portion of the Safety Violation Form to SAFETY group for the further necessary action against the BA. **The cumulative nos. of Safety Violations pertaining to any particular BA shall be calculated on yearly basis.**

Safety violations resulting in incident / accident will be treated as per gravity of the injury / fatality and its impact as well as type i.e. minor or Major. Consequences of incident / accident are shown in the matrix (figure 6.3(2) for major and 6.3(3) for minor) below. In case of any accident, findings and recommendations of Accident Enquiry Committee will be final and binding and will supersede the arbitration clause of GCC.

Consequence Of an Incident / Accident (In case of MAJOR contract)		Incident / Accident				Action Required
Sl. No	Type of the injury	1st	2nd	3rd	4th	
1	Slight injury (First Aid Case)	F (Strengthening of process through continuous improvement in the work procedure)				Take risk reduction measures
2	Minor injury (No or Hospitalization less than 48 Hrs)	F	G	G	H	
3	Major injury (Bone injury or burn or Hospitalization more than 48 Hrs)	G	G	H	I	
4	Single fatality	J	K			Intolerable
5	Multiple fatalities (Two or more fatalities during one event)	K				
Legend	Action to be taken	Responsibility	Penalty (in Rs.)	<i>The number of violations are to be calculated cumulatively over the contract period and not on monthly basis.</i>		
F	Memo to BA and levy of penalty	Engineer Incharge	5,000/-			
G	Memo to BA and levy of penalty	Head of Group	20,000/-			
H	Memo to BA and levy of penalty	Head of Group	50,000/-			
I	Memo to BA and levy of penalty	Head of Department	2,00,000/-			
J	Memo to BA and levy of penalty	Head of Department	5,00,000/-			
K	Memo to BA, levy of penalty, termination of contract and black listing of BA	Functional Head	10,00,000/-			

Figure 6.3 (2) - Penalty Matrix for Incident / Accident in Major Contracts

(For example: In major contracts, if there is first incidence of major injury say bone injury (Cat. 3) where worker was hospitalized for more than 48 hrs then a penalty of amount Rs.20000/- will be deducted from the current bill produced for the payment. This penalty will be similar for first two incidents. However, it will increment to next higher category i.e. Rs. 50,000/- on subsequent incidents as per the above matrix)

Consequence Of an Incident / Accident (In case of <u>MINOR</u> contract)		Incident / Accident				Action Required
Sl. No	Type of the injury	1st	2nd	3rd	4th	
1	Slight injury (First Aid Case)	L (Strengthening of process through continuous improvement in the work procedure)				Take risk reduction measures
2	Minor injury (No or Hospitalization less than 48 Hrs)	L	M	M	N	
3	Major injury (Bone injury or burn or Hospitalization more than 48 Hrs)	M	M	N	O	
4	Single fatality	P	Q			Intolerable
5	Multiple fatalities (Two or more fatalities during one event)	Q				
Legend	Action to be taken	Responsibility		Penalty (in Rs.)		<i>The number of violations are to be calculated cumulatively over the contract period and not on monthly basis.</i>
L	Memo to BA and levy of penalty	Engineer Incharge		5,000/-		
M	Memo to BA and levy of penalty	Engineer Incharge		10,000/-		
N	Memo to BA and levy of penalty	Head of Group		25,000/-		
O	Memo to BA and levy of penalty	Head of Department		1,00,000/-		
P	Memo to BA and levy of penalty	Head of Department		3,00,000/-		
Q	Memo to BA, levy of penalty, termination of contract and black listing of the BA	Functional Head		5,00,000/-		

Figure 6.3 (3) - Penalty Matrix for Incident / Accident in Minor Contracts

(For example: In minor contracts, if a worker meets with a non-fatal accident say bone injury (Cat. 3) where he was hospitalized for more than 48 hrs then a penalty of amount Rs. 10,000/-, will be charged from the current bill produced for the payment. This penalty will be similar for first two incidents. However, it will increment to next higher category i.e. Rs. 25,000/- on subsequent incidents as per the above matrix.)

In case of single or multiple fatalities described under legends J&K of 6.3(2) and P&Q of 6.3(3), the concerned BA may be debarred from extension of contract or participate in new contract. In such event the approval of Chief (O & S) will be necessary for extension or award of new contract to concerned BA.

6.3.2 COMPENSATION FOR BA PERSONNEL

In the event of any untoward incident/ accident, the Business Associate shall ensure prompt medical assistance such as treatment, sickness benefit, etc. is provided to the victim(s) as per the Employees' Compensation Act, 1923 or Employees' State Insurance Act, 1948, as applicable. Also, the BA will be required to take adequate measures for compensating the victim(s) or his/her/their kin as follows:

I. For Death or Permanent / Total Disablement

The BA shall take an insurance coverage of at least Rs. 15 lakhs for each engaged employee, to cover any incidence of Death or Permanent / Total Disablement (Permanent/Total Disability shall be considered as defined under Employees' Compensation Act, 1923). In the event of any such unfortunate incident, the BA would ensure that adequate compensation is paid immediately to the family of the victim(s) from his own resources. This compensation shall be covered under the insurance policy subscribed by the BA mentioned earlier and the arrangement should be such that it would get reimbursed to the BA by the insurance agency subsequently.

Doc. Title	GENERAL CONDITIONS OF CONTRACT - COMPOSITE WORKS	
Rev. No	0	Page 73 of 104

II. For Permanent Partial Disablement and Temporary Total Disablement

The compensation in this case will be as per provisions of the Employees' Compensation Act, 1923 or Employees' State Insurance Act, 1948, as applicable.

Accordingly, the BA shall obtain a suitable Insurance Policy on award of Contract and submit documentary evidence of the policy to the BA Cell before commencement of work. The BA shall ensure that the Insurance policy is active at all times and all employees are covered in all respects till the conclusion of contract period or till working with TPCODL. The BA shall submit a copy of the policy after periodic renewals to the BA Cell.

However, on occurrence of such unfortunate incident, if it is found that the victim(s) is/are not covered under any insurance policy, the BA shall be liable to pay the entire sum of Rs. 10 lakhs from his own resources.

Further, in case of an accident resulting in Death or Permanent / Total Disablement while on duty, the appointed BA Nodal Officer will ensure that the BA complies with all statutory provisions and benefits i.e. PF, Compensation, Gratuity etc., and that all these are made available to the employees' nominee(s) as per the stipulated timelines.

6.3.3 TPCODL rewards the BA with good track record of safety management. It is proposed that BA complying with Contractors Safety Management, Safety Manual and Safety process will be rewarded suitably as per the procedure, rule and regulations of the TPCODL. In any case major accident is reported during an assessment period BA will not be eligible for this reward scheme. Assessment of contracts will be once in year. Generally the assessment cycle is calendar year and guidelines will be declared time to time.

Abbreviations Used in the Document

TPCODL	TP Central Odisha Distribution Limited
BA	Business Associate
HIRA	Hazard Identification & Risk Assessment
JSA	Job Safety Analysis
EHV	Extra High Voltage
SAFETY	Safety, Occupation Health, Environment & Disaster Management
MMG	Meter Management Group
EAG	Energy Audit Group
PPE	Personal Protective Equipment
SOP	Standard Operating Procedures
CSI/SI	Circle Safety In-charge / Safety In-charge
ASO	Area Safety Officer
NSO	Nodal Safety Officer
SC	Safety Coordinator
HoG / HoD	Head of Group / Head of Department
AGM / GM / VP	Assistant General Manager / General Manager / Vice President

Doc. Title	GENERAL CONDITIONS OF CONTRACT - COMPOSITE WORKS	
Rev. No	0	Page 74 of 104

CFO / Chief (O & S)/ CEO & MD	Chief Finance Officer / Chief (Operating & Safety) / Chief Executive Officer & Managing Director
COS	Corporate Operation Services
CAP	Centralized Account Payable System
PTW	Permit To Work
GCC	General Conditions of Contract.

- END -

GENERAL CONDITIONS OF CONTRACT

Doc. Title	GENERAL CONDITIONS OF CONTRACT - COMPOSITE WORKS	
Rev. No	0	Page 75 of 104

Annexure 1 (Refer Para 3.1)

Business Associate Safety Management System Questionnaire

Certification				
The information provided in this questionnaire is a summary of the company's occupational health and safety management system.				
Company Name:				
Turnover and experience:		Name of top officer:		
Date:		Position		
Contract Details				
Contract Name		Contract Number:		
Business Associates Safety Management System Questionnaire	Marks	Yes	No	Score achieved
<i>Safety Policy and Management</i>				
- Is there a written company Safety policy? - If yes provide a copy of the policy, if No please refer Note 1.	1			
- Does the company have an Safety Management system - If yes provide details, if No please refer Note 1.	1			
- Is there a company Safety Management System manual or plan? - If yes provide a copy of the content page(s), if No please refer Note 1.	2			
- Are Safety and occupational health responsibilities clearly identified for all levels of Management and staff? - If yes provide details, if No please refer Note 1.	2			
<i>Safe Work Practices and Procedures</i>				
- Has the company prepared safe operating procedures or specific safety instructions relevant to its operations and relevant work as per contract? - If yes provide a summary listing of procedures or instructions, if No please refer Note 2.	1			

Certification				
- Comments				
- Is there a register of injury or accident? - If yes provide a copy (format)	1			
- Is there a documented incident or accident investigation procedure? - If yes provide a copy of a standard incident report form, if No please refer Note 2. - Comments	1			
<i>Safety Training</i>				
- Describe how occupational health and safety training is conducted in your company If No please refer Note 1.	2			
- Is a record maintained of all training and induction programs undertaken for employees in your company? - If yes provide examples of safety training records, if No please refer Note 2.	1			
- Are regular safety inspections / audits are undertaken at worksites? -If yes provide details (formats), if No please refer Note 3.	1			
- Is there a procedure by which employees can report hazards at workplaces? - If yes provide details if No please refer Note 1.	1			
<i>Safety Monitoring</i>				
- Is there an officer / supervisor responsible for monitoring workplace / worksite safety?	1			

Doc. Title	GENERAL CONDITIONS OF CONTRACT - COMPOSITE WORKS		
Rev. No	0	Page 77 of 104	

Certification				
- If yes provide details				
<i>Safety Performance Monitoring</i>				
- Are employees regularly provided with information on company health and safety performance? - If yes provide details	1			
- Has the company ever been convicted of an occupational health and safety offence? - If yes provide details	NO Marks (Negative mark ONE for each case)			
- Has there been any major accident of employee at TPCODL site in past	NO Marks (Negative mark ONE for each case)			
- Has there been any fatal accident of employee at TPCODL site in past. - (Note: Bid evaluation committee has to take cognizance of the incident and shall evaluate the bid only after formal approval of competent authority i.e. CTO. - In case of yes please refer Note 4.	NO Mark (Negative mark FIVE for each case)			
Minimum of 75% marks is required for qualification.		Total Marks achieved		
<i>Company Reference</i>				
1. Name of company 2. Name of company				

Note

1: If company does not have formal procedure on Safety Management System than vendor may submit proposed Safety road map along with safety action plan and brief safety policy on his letter head signed by head of the organization.

2: The vendor may submit the same in the Safety Action Plan.

3: The vendor may utilize the same format of TPCODL or on request SAFETY group will assist the vendor in developing the audit system. For other points also vendor may take the assistance of SAFETY group for development of Safety management system.

Doc. Title	GENERAL CONDITIONS OF CONTRACT - COMPOSITE WORKS	
Rev. No	0	Page 78 of 104

4: The vendor may submit the Safety Improvement Plan and Safety Action Plan for his employees based on following points.

- i. Action plan for enhancing safety awareness*
- ii. Action plan for safety training of employee*
- iii. Action plan for increasing safety audit in field*
- iv. Action plan for provision and utilization of safety PPE.*
- v. Action plan for fatality reduction.*
- vi. Action plan for enhanced supervision at site*
- vii. Action plan for making employee more responsible and accountable for safety.*
- viii. Action plan for availability and utilization of all required tool and equipment.*
- ix. Safety Improvement done in last two years, specially highlighting those which have been taken after the fatal accident along with results.*
- x. Safety initiatives planed or started recently.*
- xi. Any other point.*

Based on above points and documentary evidences vendor will be required to submit a detailed report in support of his bid. The bid evaluation committee and competent authority will scrutinize the facts and the evidence submitted. If found satisfactory competent authority i.e. CTO may accord his approval for bid opening otherwise his tender shall be disqualified.

Annexure 2 (Refer Para 3.2 and 5.8)

Risk Assessment Form

Business Associate:
Scope of the work:
BA's Representative:
Telephone:
Signature:
Date:

Specific Task/Activity	Potential Hazards/Consequences	Class of Risk	Control Measures
Working at Height	Fall from height	2	<ol style="list-style-type: none"> 1. Mandatory usage of JSA checklist prior to start of work 2. Use appropriate ladder 3. Use full body safety harness having double lanyard. 4. Use Electrical Safety Shoes if working on electrical network otherwise use safety shoes. 5. Use Safety helmet. 6. Use PPE as per the annexure 7 of this CSM document 7. Refer Work instruction related to Working at Height for other details 8. Use of metal scaffold to be ensured in height work (cup lock type) 9. Deploy competent workforce who are medically fit

Specific Task/Activity	Potential Hazards/Consequences	Class of Risk	Control Measures
Working on electrical equipment / network	Electric flash / electrocution	3	<ol style="list-style-type: none"> 1. Mandatory usage of JSA checklist prior to start of work 2. Use Electrical Safety Shoes while working on electrical network. 3. Use Electrical Safety gloves of appropriate voltage rating. 4. Use face shield / visor attached with helmet. 5. Use Safety helmet. 6. Use PPE as per the annexure 7 of this CSM document 7. Mandatory usage of Insulated tools & tackles on electrical system 8. Mandatory compliance for Lock Out & Tag out system. Refer Work instruction related to Working on electrical equipment / network for other details
Excavation / Civil work	Collapse of soil, Fall in excavated pit leading to Injury	2	<ol style="list-style-type: none"> 1. Use safety shoes. 2. Use Safety helmet. 3. Use PPE as per the annexure 7 of this CSM document 4. Hard Barricading of the worksite. 5. Refer Work instruction related to excavation / civil work for other details
Material lifting & Mechanical Erection work	Fall of material/object, Topple of crane,	2	<ol style="list-style-type: none"> 1. Mandatory compliance of crane checklist 2. Visual condition check of lifting tools and tackles such as wire rope sling, belt sling, chain, pulley block, D-shackles, etc. shall be ensured. 3. The operator's physical fitness and alertness should be judged by sup. / EIC. 4. Use PPE as per the annexure 7 of this CSM document 5. Refer Work instruction related to Material lifting & Mechanical Erection work
Road Safety	Road Accidents	3	<ol style="list-style-type: none"> 1. Mandatory compliance of TPCODL Road Safety policy W07(COR-P-12)

Doc. Title	GENERAL CONDITIONS OF CONTRACT - COMPOSITE WORKS	
Rev. No	0	Page 81 of 104

Specific Task/Activity	Potential Hazards/Consequences	Class of Risk	Control Measures
------------------------	--------------------------------	---------------	------------------

Note: This information for the general indication purpose. The detailed risk assessment shall be conducted before start of the work by the authorized representative of the BA. The report of same shall be submitted to engineer in-charge along with annexure 4 of the CSM document.

Guidelines for filling the Risk Assessment Form

- *Specific Task/Activity* - The documentation of each major task associated with the contract.
- *Potential Hazards* - The identification of hazards associated with each activity or task to be carried out.
- *Class of Risk* - Each hazard should be evaluated as a level of risk, described as Risk Class 1, 2 or 3 defined above.
- *Control Measure* - The identification and documentation of actions required to eliminate or reduce the hazards that could lead to accident or injury.

Hazard / Risks shall be classified according to the following schedule:

- Class 1: Potential to cause injury treatable with first aid
- Class 2: Potential to cause death or permanent injury
- Class 3: Potential to cause more than one or more lost time injuries.

GENERAL CONDITIONS OF CONTRACT

Annexure 3.1 (Refer Para 4.0)

General Safety Conditions for the Maintenance of Distribution Network Contracts:

A BA awarded a contract (O&M) work of maintenance of distribution network will be required to fulfil the following conditions:

- BA shall provide Safety Policy and safety objectives of their company.
- BA shall comply with all statutory requirements like: applicable acts, regulations, codes of practice, OHSAS Standards, etc.
- BA shall provide the filled safety management questionnaire as per Annexure 1
- BA shall conduct a job risk assessment and provide information as per Annexure 2
- BA shall abide by Safety manuals, guidelines of TPCODL.
- BA shall provide its organisation structure & responsibilities in terms of Safety Management to TPCODL.
- BA shall document the work practices and procedures in terms of Safety Management.
- BA shall ensure safety training and induction program for the employees
- BA shall conduct safety audits & inspections as per TPCODL procedures provided by SAFETY group.
- BA shall provide and ensure the proper usage of the safety equipment (PPE) as per the TPCODL approved list in *annexure 7*.
- BA shall ensure periodic inspection of PPE to ensure its serviceability as per the specification given by TPCODL.
- BA shall ensure the adherence to standard operating procedures or guidelines laid down by TPCODL.
- BA shall ensure reporting of any unsafe act, unsafe conditions, near miss, incident or accident to engineer in-charge and SAFETY team of TPCODL.
- BA shall provide safety performance and Safety MIS (*annexure 9*) to engineer in-charge and SAFETY group periodically. Based on any non-confirmation to the safety procedures and guidelines, BA is liable to be negatively marked for his performance and suitable penalty will be imposed.
- BA shall ensure to depute a Safety Supervisor for managing a complete safety management system in a district. In case the BA has been awarded work in more than one district, then the following safety structure will be adopted.

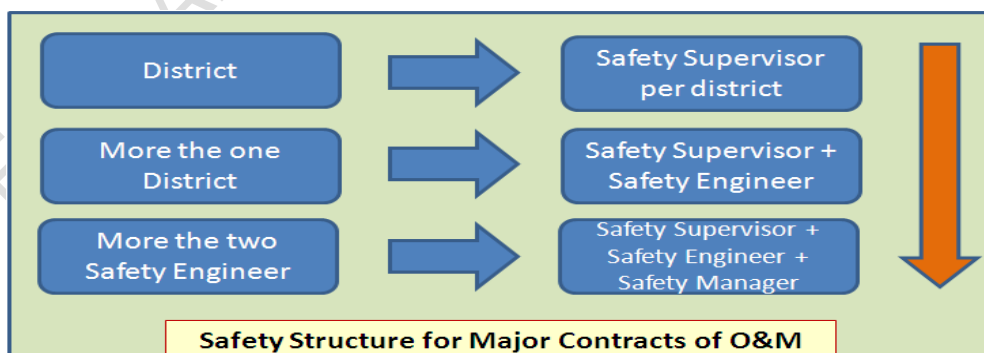

Annexure 3.2 (Refer Para 4.0)

General Safety Conditions for the Distribution Projects Major Contracts:

A BA awarded a major contract work of TS&P in area of a circle will be required to fulfil the following conditions:

- BA shall provide Safety Policy and safety objectives of their company.
- BA shall comply with all statutory requirements like: applicable acts, regulations, codes of practice, OHSAS Standards, etc.
- BA shall provide the filled safety management questionnaire as per Annexure 1.
- BA shall conduct a job risk assessment and provide information as per Annexure 2
- BA shall abide by Safety manuals, guidelines of TPCODL.
- BA shall provide its organisation structure & responsibilities in terms of Safety Management to TPCODL.
- BA shall document the work practices and procedures in terms of Safety Management.
- BA shall ensure safety training and induction program for the employees
- BA shall conduct safety audits & inspections as per TPCODL procedures provided by SAFETY group.
- BA shall provide and ensure the proper usage of the safety equipment (PPE) as per the TPCODL approved list in annexure 7.
- BA shall ensure periodic inspection of PPE to ensure its serviceability as per the specification given by TPCODL.
- BA shall ensure the adherence to standard operating procedures or guidelines laid down by TPCODL.
- BA shall ensure reporting of any unsafe act, unsafe conditions, near miss, incident or accident to engineer in-charge and SAFETY team of TPCODL.
- BA shall provide safety performance and Safety MIS (*annexure 9*) to engineer in-charge and SAFETY group periodically. Based on any non-confirmation to the safety procedures and guidelines, BA is liable to be negatively marked for his performance and suitable penalty will be imposed.
- BA shall ensure to depute a Safety Supervisor for managing a complete safety management system in the area. In case the BA has been awarded work in more than one circle, then the following safety structure will be adopted.

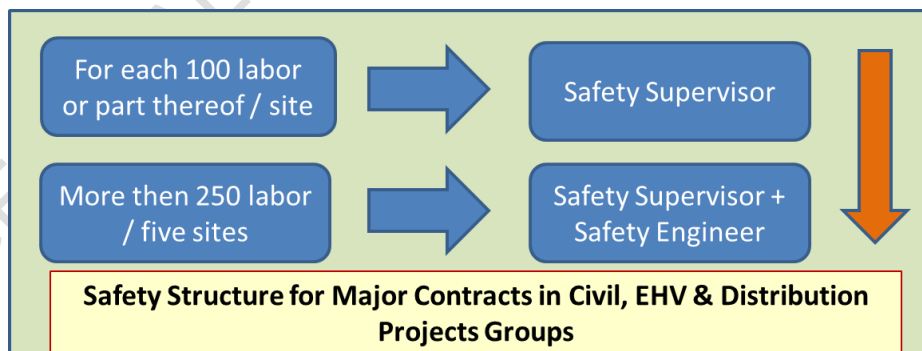

Annexure 3.3 (Refer Para 4.0)

General Safety Conditions for the major EHV Projects Contracts:

A BA awarded a major contract work of EHV projects will be required to fulfil the following conditions:

- BA shall provide Safety Policy and safety objectives of their company.
- BA shall comply with all statutory requirements like: applicable acts, regulations, codes of practice, OHSAS Standards, etc.
- BA shall provide the filled safety management questionnaire as per Annexure 1
- BA shall conduct a job risk assessment and provide information as per Annexure 2
- BA shall abide by Safety manuals, guidelines of TPCODL.
- BA shall provide its organisation structure & responsibilities in terms of Safety Management to TPCODL.
- BA shall document the work practices and procedures in terms of Safety Management.
- BA shall ensure safety training and induction program for the employees
- BA shall conduct safety audits & inspections as per TPCODL procedures provided by SAFETY group.
- BA shall provide and ensure the proper usage of the safety equipment (PPE) as per the TPCODL approved list in annexure 7.
- BA shall ensure periodic inspection of PPE to ensure its serviceability as per the specification given by TPCODL.
- BA shall ensure the adherence to standard operating procedures or guidelines laid down by TPCODL.
- BA shall ensure reporting of any unsafe act, unsafe conditions, near miss, incident or accident to engineer in-charge and SAFETY team of TPCODL.
- BA shall provide safety performance and Safety MIS (*annexure 9*) to engineer in-charge and SAFETY group periodically. Based on any non-confirmation to the safety procedures and guidelines, BA is liable to be negatively marked for his performance and suitable penalty will be imposed.
- BA shall ensure to depute a Safety Supervisor for managing a complete safety management system in the area. In case the BA has been awarded work in more than one circle, then the following safety structure will be adopted.
- BA shall refer Construction Safety Manual in TPCODL Safety Manual for details.

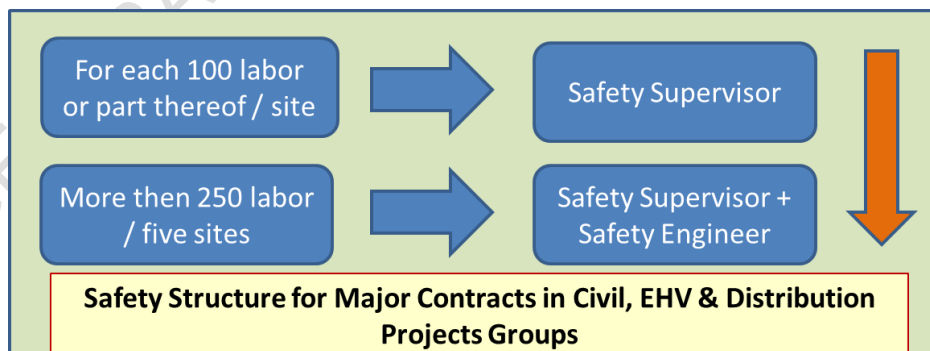

Annexure 3.4 (Refer Para 4.0)

General Safety Conditions for the Maintenance of Sub – Transmission Network Contracts:

A BA awarded a major contract work of maintenance of sub – transmission network in area of a power system will be required to fulfil the following conditions:

- BA shall provide Safety Policy and safety objectives of their company.
- BA shall comply with all statutory requirements like: applicable acts, regulations, codes of practice, OHSAS Standards, etc.
- BA shall provide the filled safety management questionnaire as per Annexure 1
- BA shall conduct a job risk assessment and provide information as per Annexure 2
- BA shall abide by Safety manuals, guidelines of TPCODL.
- BA shall provide its organisation structure & responsibilities in terms of Safety Management to TPCODL.
- BA shall document the work practices and procedures in terms of Safety Management.
- BA shall ensure safety training and induction program for the employees
- BA shall conduct safety audits & inspections as per TPCODL procedures provided by SAFETY group.
- BA shall provide and ensure the proper usage of the safety equipment (PPE) as per the TPCODL approved list in annexure 7.
- BA shall ensure periodic inspection of PPE to ensure its serviceability as per the specification given by TPCODL.
- BA shall ensure the adherence to standard operating procedures or guidelines laid down by TPCODL.
- BA shall ensure reporting of any unsafe act, unsafe conditions, near miss, incident or accident to engineer in-charge and SAFETY team of TPCODL.
- BA shall provide safety performance and Safety MIS (*annexure 9*) to engineer in-charge and SAFETY group periodically. Based on any non-confirmation to the safety procedures and guidelines, BA is liable to be negatively marked for his performance and suitable penalty will be imposed.
- BA shall ensure to depute a Safety Coordinator for managing a complete safety management system in the area. In case the BA has been awarded work in more than one area power system, then the following safety structure will be adopted.



Annexure 3.5 (Refer Para 4.0)

General Safety Conditions for the major contract work in Civil / Generation Projects:

A BA awarded a major contract work of / in civil or Generation project will be required to fulfil the following safety conditions:

- BA shall provide Safety Policy and safety objectives of their company.
- BA shall comply with all statutory requirements like: applicable acts, regulations, codes of practice, OHSAS Standards, etc.
- BA shall provide the filled safety management questionnaire as per Annexure 1
- BA shall conduct a job risk assessment and provide information as per Annexure 2
- BA shall abide by Safety manuals, guidelines of TPCODL.
- BA shall provide its organisation structure & responsibilities in terms of Safety Management to TPCODL.
- BA shall document the work practices and procedures in terms of Safety Management.
- BA shall ensure safety training and induction program for the employees
- BA shall conduct safety audits & inspections as per TPCODL procedures provided by SAFETY group.
- BA shall provide and ensure the proper usage of the safety equipment (PPE) as per the TPCODL approved list in annexure 7.
- BA shall ensure periodic inspection of PPE to ensure its serviceability as per the specification given by TPCODL.
- BA shall ensure the adherence to standard operating procedures or guidelines laid down by TPCODL.
- BA shall ensure reporting of any unsafe act, unsafe conditions, near miss, incident or accident to engineer in-charge and SAFETY team of TPCODL.
- BA shall provide safety performance and Safety MIS (*annexure 9*) to engineer in-charge and SAFETY group periodically. Based on any non-confirmation to the safety procedures and guidelines, BA is liable to be negatively marked for his performance and suitable penalty will be imposed.
- BA shall ensure to depute a Safety Supervisor (for workforce upto 100 at site) / a safety engineer (for workforce upto 250 at site) / safety manager (for more than two safety engineers) for managing a complete safety management system at the project site. In case the BA has been awarded more than one major contracts, then the following safety structure will be adopted.
- BA shall refer Construction Safety Manual in TPCODL Safety Manual for details.



Doc. Title	GENERAL CONDITIONS OF CONTRACT - COMPOSITE WORKS	
Rev. No	0	Page 87 of 104

Annexure 3.6 (Refer Para 4.0)

General Safety Conditions for the major contract work in Commercial Department like - MMG, RRG, EAG, etc.:

A BA awarded a major contract work in meter management group & energy auditing group will be required to fulfil the following safety conditions:

- BA shall provide Safety Policy and safety objectives of their company.
- BA shall comply with all statutory requirements like: applicable acts, regulations, codes of practice, OHSAS Standards, etc.
- BA shall provide the filled safety management questionnaire as per Annexure 1
- BA shall conduct a job risk assessment and provide information as per Annexure 2
- BA shall abide by Safety manuals, guidelines of TPCODL.
- BA shall provide its organisation structure & responsibilities in terms of Safety Management to TPCODL.
- BA shall document the work practices and procedures in terms of Safety Management.
- BA shall ensure safety training and induction program for the employees
- BA shall conduct safety audits & inspections as per TPCODL procedures provided by SAFETY group.
- BA shall provide and ensure the proper usage of the safety equipment (PPE) as per the TPCODL approved list in annexure 7.
- BA shall ensure periodic inspection of PPE to ensure its serviceability as per the specification given by TPCODL.
- BA shall ensure the adherence to standard operating procedures or guidelines laid down by TPCODL.
- BA shall ensure reporting of any unsafe act, unsafe conditions, near miss, incident or accident to engineer in-charge and SAFETY team of TPCODL.
- BA shall provide safety performance and Safety MIS (*annexure 9*) to engineer in-charge and SAFETY group periodically. Based on any non-confirmation to the safety procedures and guidelines, BA is liable to be negatively marked for his performance and suitable penalty will be imposed.
- BA shall ensure to depute a Safety Supervisor for managing a complete safety management system for the work as per the following safety structure.
- The BA for the RRG work shall depute one Safety supervisor.

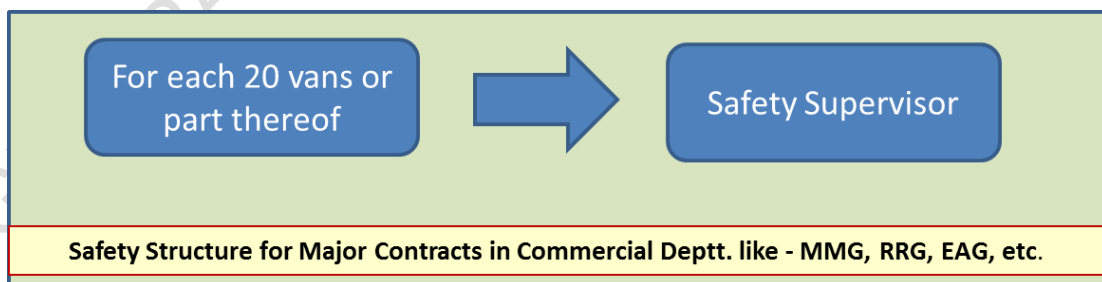

Annexure 3.7 (Refer Para 4.0)

General Safety Conditions for the major contract work in O&M of street light group:

A BA awarded a major contract work in operation and maintenance of street light group will be required to fulfil the following safety conditions:

- BA shall provide Safety Policy and safety objectives of their company.
- BA shall comply with all statutory requirements like: applicable acts, regulations, codes of practice, OHSAS Standards, etc.
- BA shall provide the filled safety management questionnaire as per Annexure 1
- BA shall conduct a job risk assessment and provide information as per Annexure 2
- BA shall abide by Safety manuals, guidelines of TPCODL.
- BA shall provide its organisation structure & responsibilities in terms of Safety Management to TPCODL.
- BA shall document the work practices and procedures in terms of Safety Management.
- BA shall ensure safety training and induction program for the employees
- BA shall conduct safety audits & inspections as per TPCODL procedures provided by SAFETY group.
- BA shall provide and ensure the proper usage of the safety equipment PPE as per the TPCODL approved list in annexure 7.
- BA shall ensure periodic inspection of PPE to ensure its serviceability as per the specification given by TPCODL.
- BA shall ensure the adherence to standard operating procedures or guidelines laid down by TPCODL.
- BA shall ensure reporting of any unsafe act, unsafe conditions, near miss, incident or accident to engineer in-charge and SAFETY team of TPCODL.
- BA shall provide safety performance and Safety MIS (*annexure 9*) to engineer in-charge and SAFETY group periodically. Based on any non-confirmation to the safety procedures and guidelines, BA is liable to be negatively marked for his performance and suitable penalty will be imposed.
- Each BA shall ensure to depute a Safety Supervisor for managing a complete safety management system for the work awarded as per the below structure.



Doc. Title	GENERAL CONDITIONS OF CONTRACT - COMPOSITE WORKS	
Rev. No	0	Page 89 of 104

Annexure 4 (Refer Para 3.3)

Safety Undertaking by way of Affidavit

I _____ s/o _____ R/o _____ (AUTHORIZED REPRESENTATIVE/PARTNER/DIRECTOR/PROPRIETOR) of M/S _____(name of company/firm)___ having its office at (Complete address of Company), authorized vide power of attorney dated -----/Board resolution dated----/letter of authority dated----, hereinafter referred to as **Contractor [or Business Associate (BA)]** which expression shall, unless it be repugnant to or inconsistent with the meaning or context thereof, be deemed to include its heirs, executors, administrators, and assigns do hereby affirm and undertake as under :

1. The present undertaking shall remain in force from the date of execution of contract awarded by TPCODL and shall be valid till the date of termination of the said contract by either parties. The undertaking is binding on me (contractor) as well as my sub-contractor and its employees, representatives etc.
2. That I(the contractor) will be responsible and liable to comply and abide by all the safety rules, instructions and regulations as may be specified and laid down by The TP Central Odisha Distribution Limited (TPCODL) so as enable TPCODL to achieve its goal of Zero On site incidences.
3. That the Contractor shall be fully responsible for ensuring occupational health and safety of its employees, representatives, agents as well as of its subcontractor's employees, at all times during the discharge of their respective obligations under the contract including any methods adopted for performance of their tasks / work.
4. That Contractor shall ensure ,at its own expense to arrange for and procure, implement all requisite accident prevention tools, first aid boxes, personal protective equipment, fire extinguisher, safety training, Material Safety Data Sheet, pre-employment medical test, etc. for operations & activities including as & when so specified by TPCODL specifically. , failing which TPCODL shall be entitled, but not obliged, to provide the same and recover the actual cost thereof from the Contractor's payments.
5. That the Contractor shall engage adequate and competent Safety – Supervisor / Engineer / Manager / Skilled persons at site as per the Para 5 (Qualification and experience of safety personnel) and Annexure 3 of Contract Safety Management.
6. That the Contractor shall engage the competent Site – Supervisor with each group of workers for safe and correct workmanship, proper co-ordination of material and site work as per contract.

Doc. Title	GENERAL CONDITIONS OF CONTRACT - COMPOSITE WORKS	
Rev. No	0	Page 90 of 104

7. That the Contractor shall immediately replace supervisor in case it is found to be not up to the level of skill and experience required as in skill and experience required in *annexure 5* of this document, but any such replacement shall be only with the prior concurrence of TPCODL .
8. That the Contractor and its subcontractors shall abide by all the safety guidelines as per Safety Manual, Contract Safety Management and other guidelines issued from time to time by TPCODL during the contract period.
9. That in case the Contractor and/or any of its Subcontractor fail to ensure the compliance as required in terms of this undertaking the Contractor shall keep and hold TPCODL / its directors / officers / employees indemnified against any / all losses / damage / expense / liability / fines / compensation / claims / action / prosecutions or the like which might be suffered by TPCODL or to which TPCODL might get exposed to as a result of any breach /wilful negligence /deliberate default on the part of the Contractor /Subcontractor in complying with the same. Contractor shall also furnish any press release, clarification etc. if sought by TPCODL for any near miss or safety violations, accidents, which are attributable to fault of Contractor.

DEPONENT

VERIFICATION

Verified at Bhubaneswar on this _Day of _____20__ that the contents of the above affidavit are true and correct and nothing material has been concealed therefrom

DEPONENT

Doc. Title	GENERAL CONDITIONS OF CONTRACT - COMPOSITE WORKS	
Rev. No	0	Page 91 of 104

Annexure 5 (Refer Para 5.4)

SKILL / QUALIFICATION REQUIRED FOR ELECTRICIAN AND ELECTRICAL SUPERVISOR

Skill / Qualifications Required for Electrician (*Certificate of Competency Class-II*):

1. Formal education in ITI – Wireman/ Electrician trade.

OR

2. Working experience of minimum three years of practical wiring.

OR

3. Have completed three years apprenticeship course through Apprenticeship Advisor, Govt. of Odisha / other state Govt. in the trade of Lineman / Wireman / Electrician.
4. A candidate must have attained the age of Eighteen years.

Skill / Qualifications Required for Electrical Supervisor (*Certificate of Competency Class-I*):

1. Have at least five years' experience of practical wiring after passing the certificate of competency class-II i.e. electrician.

OR

2. Recognized Degree or Diploma or equivalent qualification in Electrical Engineering from any Technical institute / College or University recognized by the Board.

AND

Must have completed the training/job in rectifying the common defects in electrical line and power installation for a period of one and three years after passing Degree or Diploma respectively

OR

3. Possessing the valid certificate of certificate of competency class – 1 (Electrical Supervisor)

Doc. Title	GENERAL CONDITIONS OF CONTRACT - COMPOSITE WORKS	
Rev. No	0	Page 92 of 104

Annexure 6 (Refer Para 5.6)

Training Module for BAs Worker & Supervisor

Training for BA Supervisor

Duration – 02 Hrs / Month

Methodology: Lecture and Practical Demonstration of Safety Zone Creation

Session: 1

Topic: Electrical Safety Aspects

Sub Topics:

1. Learning specifics of HT & LT Network of zone
2. Major type of HT / LT / service lines / street light maintenance works
3. Understanding the need of Safety
4. Understanding the safe process of maintenance :
 - Planning of the maintenance job
 - Availability of men, material & machine, PPEs, Safety gear and approved PTW
 - Briefing of the job by the supervisor of the TPCODL
 - Identification of Risks associated with the maintenance work and planning for controlling measures by TPCODL supervisor
 - Creation of safety zone by TPCODL supervisor and satisfying that the network is dead – Use of Neon Tester, Shorting Chain and Safety Tagging
 - Start of the work – Right person for the right job
 - Alert supervision
 - Completion of the job – Check points
 - Energization of network
 - Actions to be taken in case of some accident

Session: 2

Topic: Use of Electrical Testing Equipment

Methodology: Lecture and Practical Demonstration

Sub Topics:

1. Meggar, Hi Pot, Clamp On Meter, Neon Tester, Discharge Rod, Line tester etc.

Session: 3

Topic: Awareness of Electrical Safety Aspects

- A. Understanding the need of this Training and Safety
- B. Learning specifics of HT & LT Network
- C. Major type of work to be carried out in zones
- D. Switching Operations (Do's & Don'ts) including Street Light Switching
- E. Working on Height (*practical demo also*)
- F. Understanding the Safe Process of Maintenance / Working:
 - Planning of the job
 - Availability of men, material & machine, PPEs, Safety gear and approved PTW
 - Briefing of the job by the supervisor
 - Permit to Work
 - Safety Tagging and Lock Out Tag out

Doc. Title	GENERAL CONDITIONS OF CONTRACT - COMPOSITE WORKS	
Rev. No	0	Page 93 of 104

- Identification of Risks associated with the work to be carried out and planning for controlling measures by proper supervision
- Concept of “**Safety Zone**”
- Identification and use of Neon Tester, Shorting Chain, Clamp On Meter, Hi Pot, Meggar etc.
- Completion of the job – Check points
- Accident Theory & Incident Reporting
- Actions to be taken in case of some accident

Session: 4

Topic: Identification, Demonstration and Usages of Tools, PPEs and other Safety Gears and demonstration of working on HT pole

Session: 5

Topic: Practical demonstration of Safety Zone creation

FREQUENCY

Regular Safety Training Program

- It will be conducted for all field & supervisor staff of BA in such a manner that all BA Personnel attend at least two hours safety training during every month.

One Day Induction Safety Training Programs:

- This training will be for the new BA's personnel, who have been cleared by the Cross Functional Panel to undergo Safety training and who are likely to be deployed at various work sites of TPCODL by the BA, as a part of AMC / Work Contract.

Duration / Periodicity:

- Duration and periodicity has been defined above. However, this is subject to change at the discretion of TPCODL.

Annexure 7 (Refer Para 5.7)



LIST OF PERSONAL PROTECTIVE EQUIPMENT AND TESTING FREQUENCY

Sl. No.	Name of PPE	IS / EN Standard	Testing Frequency	Remarks	Ref Brand & Model
01	Leather Safety Shoes (Color – Black) with PU toe cap.	IS:15298 (Part-2)	Monthly and visual check every day for any crack or damage in the leather or sole.		BATA (Model No.- Endura L/C) Liberty (Model No. – 7198-01 HT Barton Black – Warrior)
02	HDPE Safety helmet with chin strap and ratchet type for adjustment.	IS:2925-1984	Monthly and visual check every day for any crack in shell.		Karam (PN Safetech) Joseph Leslie Accent Industries Honeywell
03	Full body harness (Safety belt)	EN 361	Monthly and visual check every day of the bends and the harness.		Karam (PN Safetech) Joseph Leslie Accent Industries
04	Electrical Safety Gloves	EN: 60903 CE marked	Weekly and visual check for any crack and blow test before every work.	Manufactured not beyond 12 months.	Make Sparian / Sumitech / CATU supplied with inner cotton glove with over glove of split leather.
05	Full face visor with safety helmet	EN: 166 CE marked (Visor)	Monthly and visual check every day for any crack in shell.	Clear acrylic visor attached with safety helmet.	Karam (PN Safetech) Joseph Leslie Accent Industries Honeywell
06	Fire Proof jacket for chest protection		Monthly and visual check every day.		
07	Safety Chain for shorting cum earthing.	As per TPCODL standard	Weekly and visual check before every work.	Made of brass, Total length – 5.5 meters and made of 12 SWG.	

Note:

1. Any other Personal Protection Equipment required beyond above list will be according to BIS or EN Standards.
2. All Personal Protection Equipment will be checked by the engineer in-charge or SAFETY group of TPCODL.
3. Safety Representative of the BA has to maintain the record of the availability, condition and checking of the PPEs.
4. All tools required as per the contract must be according to respective IS / EN standards.
5. TPCODL may revise or add the above list of PPE and their specifications as and when feel necessary. The information about new specifications /models will be circulated by the Engineer In-charge (EIC), which shall adhere by the business associated in the shortest possible time. The EIC shall issue a memo / instruction to BA with timeline for implementation. Any delay will be treated as non- compliance / safety violations. Refer picture of each PPE given in next page.

Pictures of PPE for reference purpose.

Sl. No.	Name of PPE	IS / EN Standard	Picture
01	Leather Safety Shoes (Color – Black) with PU toe cap.	IS:15298(Part-2) and with test report of electrical resistance.	
02	HDPE Safety helmet with chin strap and ratchet type for adjustment.	IS:2925-1984	
03	Full body harness (Safety belt) The straps at shoulder and thigh shall have full pad for comfort. The back shall be so designed that harness straps do not tangle with each other.	EN 361:2002 EN 358 : 2000 IS: 3521:1991/2002	

04	Electrical Safety Gloves – Composite type Soft electrical gloves as per size of individual.	EN: 60903 CE marked	
05	Full face visor with safety helmet	EN: 166 CE marked (Visor)	
06	Fire Proof jacket for chest protection		
07	Safety Chain for shorting cum earthing.	As per TPCODL standard	
08	Reflective jacket to each workmen	As per TPCODL standard	

Note : Picture shown are for indicative purpose only. Actual product may differ.

Annexure 8 (Refer Para 5.8) LIST OF AUDITS TO BE CONDUCTED

Audits	Responsibility	Freq.	Ref. Doc.
Permit to Work & Field Audit	BA Safety Representative	Weekly	F04 (COR P - 12)
Tool Bag & PPE's Audit		Weekly	F06 (COR P - 12)
First Aid Box Maintenance Record		Fortnightly	F08 (COR P - 12)
Fire Extinguisher Record <i>(Applicable for the BA involved in major construction works and have storage of flammable material at worksite)</i>		Monthly	F09 (COR P - 12)
Safety Talk Register		Weekly	F18 (COR P - 12)
Site Safety Audit		Daily	F29A (COR P - 12)

Note:

1. (BA Safety Representative has to use the formats as per Safety process COR – P – 12 of TPCODL)

Annexure 9 (Refer Para 5.9)

PERFORMANCE REPORT – SAFETY

FOR THE MONTH OF.....

Name of BA :

Name of the Project and Purchase order No:

Date of commencement of work:

Man Hour Worked in this month (No. of employees X 8 Hrs + Overtime):

Cumulative Man Hour worked:

Total Number of Minor Injury (this month): Minor Injury (Total)

Major Injury (this month): Major Injury (Total):

Detail of the Incident / Sub Standard Acts and Condition

Activity	This Month	Cumulative (Total)	Day Lost (this month)	Days Lost (Cumulative)
No. of the Incident				
No. of lost time injuries				
No. of dangerous occurrences				
No. of near miss reported				
Substandard Act/Conditions observed			Attach details of observation of this month	
Safety Violation Notice received (from TPCODL) (both in numbers and in Rs.)	No.	No.	No. of violation letter received and compliance report for the TPCODL.	
	Rs.	Rs.		

Note: Cumulative means total from date of commencement of work according to the contract.

Detail of the Accident / Near Miss Incidents:

Date and Time	Type of the incident	Name of Employee	Brief Description	Corrective and Preventive actions recommended

Details of the Safety Violations:

Date and Location	Brief Description	Name of employee involved	Action Taken

Detail of the Safety Talk / Tool Box Talk / Safety Training

Date and Location	Topic (s)	Total Number of employees (Worker / Supervisor)	Number of participants (Worker / Supervisor)

Detail of the Safety Meeting

Date and Location	Number of participants	Topics discussed	Major Observations / Innovation

Detail of the Safety Inspection /Audit: (as per TPCODL site audit checklist F29A(COR-P-12)

Date	Area / Location	Major Observations	Recommendations	Action Taken

Any other Safety, Occupational Health, Environment & Disaster Management Promotional Activity (During this month):

Date	Location	Activity	Level of Participation	Number of participation

Signature of the BA Safety Representative
HoG

Signature of ZM /

Name, E. No. and Date

Name, E. No. Date.

Note: The original form to be deposited with Engineer in-charge and a copy to SAFETY group on or before 5th of every month along with bill. List of training of the current month and status of PPE to be also mentioned individual wise.

BA may include additional lines if required. The TPCODL may revise the format as and when deemed required.

Doc. Title	GENERAL CONDITIONS OF CONTRACT - COMPOSITE WORKS	
Rev. No	0	Page 100 of 104

ANNEXURE-M
VENDOR APPRAISAL FORM

TO BE SUBMITTED BY VENDOR (To be filled as applicable)		
VENDOR:		
1.0	DETAILS OF THE FIRM	
	1.1	NAME (IN CAPITAL LETTERS) :
	1.2	TYPE OF CONCERN (PROPRIETARY) Partnership, Pvt. Ltd., Public Ltd. etc. :
	1.3	YEAR OF ESTABLISHMENT :
	1.4	LOCATION OF OFFICE POSTAL ADDRESS TELEGRAPHIC ADDRESSES, TELEX NO. FAX NO. :
	1.5	LOCATION OF MANUFACTURING UNITS :
		i) UNITS 1 :
		ii) OTHER UNITS :
2.0	PRODUCTS MANUFACTURED :	
3.0	TURNOVER DURING THE LAST 3 YEARS (TO BE VERIFIED WITH THE LATEST PROFIT & LOSS STATEMENT). :	
4.0	VALUE OF FIXED ASSETS :	
5.0	NAME & ADDRESS OF THE BANKERS :	
6.0	BANK GUARANTEE LIMIT :	
7.0	CREDIT LIMIT :	
8.0	TECHNICAL	
	8.1	NO.OF DESIGN ENGINEERS (INDICATE NO.OF YEARS EXPERIENCE IN RELATED FIELDS) :
	8.2	NO.OF DRAUGHTSMEN :
	8.3	COLLABORATION DETAILS (IF ANY) :
		8.3.1 DATE OF COLLABORATION :
		8.3.2 NAME OF COLLABORATOR :

Doc. Title	GENERAL CONDITIONS OF CONTRACT - COMPOSITE WORKS	
Rev. No	0	Page 101 of 104

		8.3.3 RBI APPROVAL DETAILS	:
		8.3.4 EXPERIENCE LIST OF COLLABORATOR	:
		8.3.5 DURATION OF AGREEMENT	:
	8.4	AVAILABILITY OF STANDARDS / DESIGN PROCEDURES / COLLABORATOR'S / DOCUMENTS (CHECK WHETHER THESE ARE LATEST/CURRENT	:
	8.5	TECHNICAL SUPPORT, BACK-UP GUARANTEE, SUPERVISION, QUALITY CONTROL BY COLLABORATOR (WHEREVER ESSENTIAL). (THIS CLAUSE IS RELEVANT WHEN VENDOR'S EXPERIENCE IS INADEQUATE)	:
	8.6	QUALITY OF DRAWINGS	:
9.0	MANUFACTURE		
	9.1	SHOP SPACE, LAYOUT LIGHTING, VENTILATION, ETC.	:
	9.2	POWER (KVA)	:
		MAINS INSTALLED	:
		UTILISED	:
		STANDBY POWER SOURCE	:
	9.3	MANUFACTURING FACILITIES (ATTACH LIST OF EQUIPMENT AS APPLICABLE)	:
		9.3.1 MATERIAL HANDLING	:
		9.3.2 MACHINING	:
		9.3.3 FABRICATION	:
		9.3.4 HEAT TREATMENT	:
		9.3.5 BALANCING FACILITY	:
		9.3.6 SURFACE TREATMENT PRIOR TO PAINTING/ COATING, POLISHING, PICKLING, PASSIVATION, PAINTING, ETC.	:
	9.4	SUPERVISORY STAFF	:
	9.5	ADEQUACY OF SKILLED LABOURS (MACHINISTS, WELDERS, ETC.)	:
	9.6	NO. OF SHIFTS	:
	9.7	TYPE OF MATERIAL HANDLED (SUCH AS CS, SS, ETC.)	:

	9.8	WORKMANSHIP	:
	9.9	MATERIAL IN STOCK AND VALUE	:
	9.10	TRANSPORT FACILITIES	:
	9.11	CARE IN HANDLING	:
10.0	INSPECTION / QC / QA / TESTING		
	10.1	NUMBER OF PERSONNEL (INDICATE NO.OF YEARS OF EXPERIENCE)	:
	10.2	INDEPENDENCE FROM PRODUCTION	:
	10.3	AVAILABILITY OF PROCEDURAL WRITE UP/QUALITY PLAN	:
	10.4	INCOMING MATERIAL CONTROL AND DOCUMENTATION	:
	10.5	RELIABILITY/REPUTATION OF SUPPLY SOURCES	:
	10.6	STAGE INSPECTION AND DOCUMENTATION	:
	10.7	SUB-ASSEMBLY & DOCUMENTATION	:
	10.8	FINAL INSPECTION AND DOCUMENTATION	:
	10.9	PREPARATION OF FINAL DOCUMENTATION PACKAGE	:
	10.10	TYPE TEST FACILITIES	:
	10.11	ACCEPTANCE TEST FACILITIES	:
	10.12	CALIBRATION OF INSTRUMENTS AND GAUGES (WITH TRACEABILITY TO NATIONAL STANDARDS) (ATTACH LIST)	:
	10.13	STATUTORY APPROVALS LIKE BIS, IBR, ETC.(AS APPLICABLE)	:
	10.14	SUB-VENDOR APPROVAL SYSTEM AND QUALITY CONTROL	:
	10.15	DETAILS OF TESTS CARRIED OUT AT INDEPENDENT RECOGNISED LABORATORIES	:
		i) FURNISH LIST OF TESTS CARRIED OUT AND THE NAME OF THE LABORATORY WHERE THE TESTS WERE CONDUCTED	:
		ii) CHECK AVAILABILITY OF CERTIFICATES AND REVIEW THESE WHEREVER POSSIBLE	:
11.0	EXPERIENCE (INCLUDING CONSTRUCTION / ERECTION / COMMISSIONING) TO BE FURNISHED IN THE FORMAT INDICATED IN APPENDIX)		
12.0	SALES, SERVICE AND SITE ORANISATIONAL DETAILS		

Doc. Title	GENERAL CONDITIONS OF CONTRACT - COMPOSITE WORKS	
Rev. No	0	Page 103 of 104

13.0	CERTIFICATE FROM CUSTOMERS (ATTACH COPIES OF DOCUMENTS)	:
14.0	POWER SITUATION	:
15.0	LABOUR SITUATION	:
16.0 *	APPLICABILITY OF SC/ST RELAXATION (Y/N) IF YES, SUPPORTING DOCUMENTS TO BE ATTACHED	
17.0	ORGANIZATIONAL DETAILS 1. PF NO 2. ESI NO 3. INSURANCE FOR WORK MAN COMPENSATION ACT NO 4. ELECTRICAL CONTRACT LIC NO 5. ITCC / PAN NO 6. SALES TAX NO 7. WC TAX REG. NO	:
18.0	DOCUMENTS TO BE ENCLOSED: 1. FACTORY LICENSE 2. ANNUAL REPORT FOR LAST THREE YEARS 3. TYPE TEST REPORT FOR THE ITEM 4. PAST EXPERIENCE REPORTS 5. ISO CERTIFICATE –QMS, EMS, OHAS, SA 6. REGISTRATION OF SALES TAX 7. COPY OF TIN NO. 8. COPY OF SERVICE TAX NO. 9. REGISTRATION OF CENTRAL EXCISE 10. COPY OF INCOME TAX CLEARANCE. 11. COPY OF PF REGISTRATION 12. COPY OF ESI REGISTRATION 13. COPY OF INSURANCE FOR WORK MAN COMPENSATION ACT NO 14. COPY OF ELECTRICAL CONTRACT LIC NO 15. COPY OF PAN NO 16. COPY OF WC TAX REGISTRATION 17. DOCUMENTS IN SUPPORT OF SC/ST RELAXATION AT S.NO.16.0 18. GST Registration No	

* Classification of BA s under SC/ST shall be governed under following guidelines:

- **Proprietorship/ Single Ownership Firm:** Proprietor of the firm should be from SC/ST community. Governing document shall be Proprietorship Deed.
- **Partnership Firm:** Only such firms shall qualify which have SC/ST partners holding equal to or more than 50% of the total ownership pattern of the firm. Governing document shall be Partnership Deed.
- **Private Limited Company:** Only such firms shall qualify which have SC/ST directors holding equal to or more than 50% of the total ownership pattern of the firm. Governing document shall be Memorandum of Understanding (MoU) and/or Article of Association (AoA).

NOTE: Certification from SC/ST Commission shall be required for deciding upon SC/ST status of a person.

Doc. Title	GENERAL CONDITIONS OF CONTRACT - COMPOSITE WORKS	
Rev. No	0	Page 104 of 104

ANNEXURE-N

MANUFACTURER AUTHORIZATION FORM

(To be submitted on OEM's Letter Head)

Date:

Tender Enquiry No.:

To,
Chief (Procurement & Stores)
TP Central Odisha Distribution Limited,
Bhubaneswar

Sir,

WHEREAS M/s. [name of OEM], who are official manufacturers of having factories at [address of OEM] do hereby authorize M/s [name of bidder] to submit a Bid in relation to the Invitation for Bids indicated above, the purpose of which is to provide the following Goods, manufactured by us

.....

and to subsequently negotiate and sign the Contract.

We hereby extend our full guarantee and warranty in accordance with the Special Conditions of Contract or as mentioned elsewhere in the Tender Document, with respect to the Goods offered by the above firm in reply to this Invitation for Bids.

We hereby confirm that in case, the channel partner fails to provide the necessary services as per the Tender Document referred above, M/s [name of OEM] shall provide standard warranty on the materials supplied against the contract. The warranty period and inclusion / exclusion of parts in the warranty shall remain same as defined in the contract issued to their channel partner against this tender enquiry.

Yours Sincerely,

For

Authorized Signatory

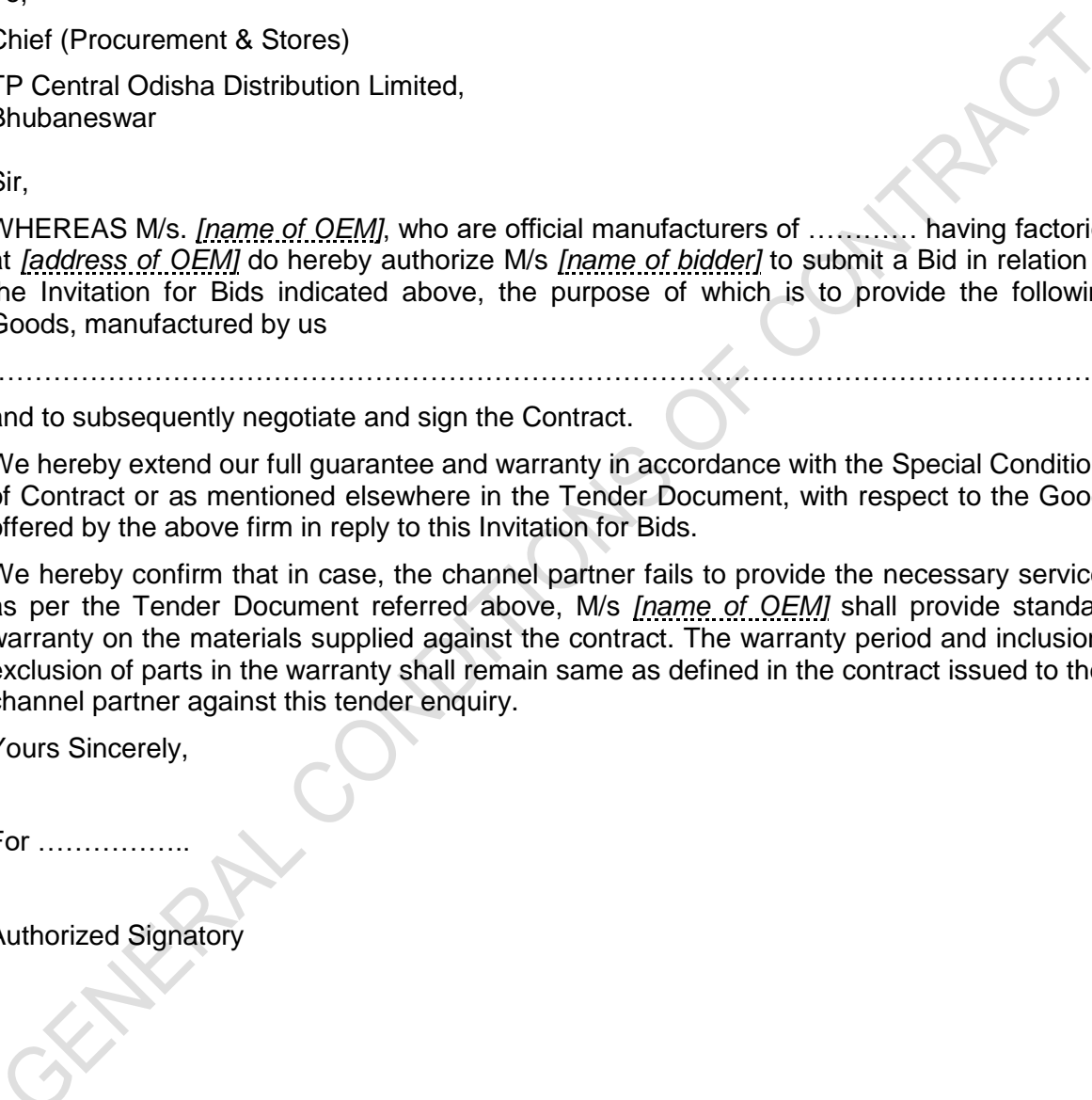

The Tata Power Company Ltd



Safety Terms and Conditions

*Document No.
TPSMS/GSR/STC/009 REV 02*

*Date of Issue:
19/01/2019*

Safety Terms and Conditions

The Tata Power Company Ltd		<i>Safety Terms and Condition</i>
<i>Document No. TPSMS/GSR/STC/009 REV 02</i>		<i>Date of Issue: 19/09/2019</i>

1.	Definitions.....	3
2.	Safety Policy.....	4
3.	Ten Commandments on Safety (Deleted)	Error! Bookmark not defined.
4.	Safety Organization & Responsibilities.....	6
4.1	Contractor Site Management and Supervision.....	6
4.2	Contractor Supervisors and General Staff.....	6
4.3	Contractor Workforce.....	7
4.4	Vendor/Contractor	7
5.	Site Safety Rules and Procedures:	8
5.1	Lock Out and Tag Out Procedure	8
5.2	Excavation Safety (Shoring and Sloping) Procedure	8
5.3	Confined Space Entry Procedure	8
5.4	Working at Height Procedure.....	9
5.5	Heavy Equipment Movement Safety Procedure	9
5.6	Mobile Crane Safety Procedure	9
5.7	Scaffold Safety Procedure	9
5.8	Electrical Safety Procedure	10
5.9	Job Safety Analysis (JSA) Procedure.....	10
5.10	Fire Safety Management Procedure	10
5.11	Permit To Work Procedure	10
5.12	Lift (Elevator) Safety Procedure	11
5.13	Working on conveyor belt Procedure	11
5.14	Handling Hazardous Materials Procedure	11
5.15	Material Handling and Storage Procedure.....	11
6.	Training and Capability Building	12
7.	Pre Employment and Periodic Medical check up	13
8.	Safety Performance Evaluation and Penalties	13

The Tata Power Company Ltd		<i>Safety Terms and Condition</i>
<i>Document No. TPSMS/GSR/STC/009 REV 02</i>		<i>Date of Issue: 19/09/2019</i>

1. Definitions

- 1.1 **Order Manager:** Order Manager is the Tata Power representative, who has the ownership of the given job under the signed contract.
- 1.2 **Service Provider/Contractor/vendor:** An individual or an organization that provides services to Tata Power under a signed contract.
- 1.3 **Site Safety Management Plan:** It is the safety plan agreed between Contractor /service provider & Tata Power. It will contain the entire job specific safety requirement and will be signed by the service provider.
- 1.4 **High Risk Job:** Any job which has significant health and safety risk associated to it. The list of high risk jobs has been identified at Tata Power level.
- 1.5 **Emergency:** a serious, unexpected, business discontinuity and often dangerous situation resulting loss of revenue/property and requiring immediate action.

The Tata Power Company Ltd		<i>Safety Terms and Condition</i>
<i>Document No. TPSMS/GSR/STC/009 REV 02</i>		<i>Date of Issue: 19/09/2019</i>

2. Safety Policy





HEALTH AND SAFETY POLICY

Tata Power is committed to provide safe and healthy working environment for the prevention of work related injuries and ill-health. Safety is one of our core values. We strive to be a leader in safety excellence in the global power and energy business. In pursuit of this, we are committed to the following:

- Maintain and continually improve our management systems to eliminate hazards and reduce health & safety risks to all our stakeholders.
- Incorporate appropriate health & safety criteria into business decisions for selection of plant and technology, performance appraisal of individuals and appointments in key positions.
- Comply and endeavour to exceed all applicable health & safety legal and other requirements
- Integrate health & safety procedures and best practices into every operational activity with assigned line-functional responsibilities at all levels.
- Involve our employees and business associates in maintaining a safe and healthy work environment through consultation and participation
- Inculcate safety culture by visible leadership and empowerment.
- Ensure required competency to enable our employees and business associates for working safely.
- ▶ Promptly report incidents, investigate, share crucial learnings and prevent recurrences.
- Influence our business associates in enhancing their health and safety standards and align with Tata Power's health & safety codes and practices.
- Set safety & health metrics as indicators of excellence, monitor progress and continually improve health and safety performance.

We shall ensure the availability of appropriate resources at all times to fully implement and communicate this policy to all stakeholders by suitable means and periodically review its relevance in continuously changing business environment.

Date: 11th March, 2019

 Lighting up Lives!

 (Praveer Sinha)
 CEO & Managing Director



The Tata Power Company Ltd		<i>Safety Terms and Condition</i>
<i>Document No. TPSMS/GSR/STC/009 REV 02</i>		<i>Date of Issue: 19/09/2019</i>

THIS PAGE DELETED

The Tata Power Company Ltd		<i>Safety Terms and Condition</i>
<i>Document No. TPSMS/GSR/STC/009 REV 02</i>		<i>Date of Issue: 19/09/2019</i>

3. Safety Organization & Responsibilities

4.1 Contractor Site Management and Supervision

Each Contractor will be responsible for fulfilling all statutory and safety requirements as per the laws of the land and not limited to Factory Act, Electricity Act, Electricity Rules and Regulations, Shop and Establishment Act etc.

Each Contractor shall provide at least one competent full time safety supervisor for workforce of less than 100 numbers. When workforce ranges from 100 to 1000, the contractor has to provide at least one qualified safety officer and safety supervisors (reporting to the safety officer) in the ratio 1:100. For every 1000 addition in workforce, the contractor has to add 1 safety officer. The Tata Power Project Safety Manager will review and approve the appointment of all safety supervisors. Contractor/Subcontractor safety supervisors/officers will work with Tata Power Safety Managers and align themselves with Tata Power safety requirements.

Each Contractors'/Subcontractors' Site Manager is responsible, and will be held accountable, for the safety of their sub contractors and workforce and for ensuring that all equipment, materials, tools and procedures remain in safety compliance at job site, including:

- 4.1.1 Holding officer/supervisors accountable for safety and actively promote safe work performance.
- 4.1.2 Participate in and cooperate with all safety program requirements to be implemented in order to meet Tata Power safety objectives.
- 4.1.3 Ensure timely reporting of safety incidents, near misses, unsafe acts and conditions.
- 4.1.4 Identify the training needs of its employees and maintain all safety training documents.
- 4.1.5 Provide safety performance report at an agreed frequency.
- 4.1.6 Stopping of unsafe work (acts and/or conditions) immediately, until corrective action be taken.

4.2 Contractor Supervisors and General Staff

Contractors' site supervisors and general staff members in charge of job site functions such as field engineering, warehousing, purchasing, cost and scheduling, etc. are responsible for the safe performance of the work of those they supervise. They must set an example for their fellow employees by being familiar with applicable sections of the Site Safety program and ensuring that all site activities are performed with SAFETY as the primary objective.

The Tata Power Company Ltd		<i>Safety Terms and Condition</i>
<i>Document No. TPSMS/GSR/STC/009 REV 02</i>		<i>Date of Issue: 19/09/2019</i>

Each site supervisor is responsible and will be held accountable for identifying, analyzing and eliminating or controlling all hazards through implementation of an aggressive, pro-active Health, Safety and Environmental Program from project inception through project completion. Each supervisor will proactively participate in the SHE program by observing, correcting unsafe acts, and recording these observations.

4.3 Contractor Workforce

Contractor workforce must make safety a part of their job by following safety rules and regulations and by using all safeguards and safety equipments. They must take an active part in the Site Safety program to ensure their own safety and injury-free employment as well as being alert to unsafe practices of their fellow employees.

Every member of the workforce is expected to report for work without influence of any Drug/Alcohol. All employees are expected to report any hazardous conditions practices and behaviors in their work areas and correct where ever possible.

Workforce is responsible for active participation in safety and health programs, suggestion systems, trainings and in immediate reporting of all injuries, any unsafe practices, conditions or incidents to their supervisors.

4.4 Vendor/Contractor

Vendors/Contractor shall at all times comply with, and ensure that their workforce comply with all site safety rules and regulations. Specifically, with applicable provisions of the Tata Power Site Safety Management Plan, and all statutory safety rules and regulations.

The Tata Power Company Ltd		<i>Safety Terms and Condition</i>
<i>Document No. TPSMS/GSR/STC/009 REV 02</i>		<i>Date of Issue: 19/09/2019</i>

4. Site Safety Rules and Procedures:

The work in the safest possible manner can only happen when it has been carefully planned and all applicable procedures are followed. The Tata Power Safety Procedures are derived from Tata Power best practices and the applicable Government acts regulations. In each case, the most stringent regulation is used.

Following is the list of Tata Power’s critical Safety Rules and Procedures. Contractor shall refer to approved Rules and Procedures for detailed requirements and ensure conformance.

5.1 Lock Out and Tag Out Procedure

This procedure is intended to be used for the protection of Personnel while servicing or performing maintenance on equipment / pipeline / vessel / process systems. This is a general procedure that shall be used as the minimum requirements for isolation of equipment, pipelines, machines, system from all possible sources of hazardous energy and / or material such as Steam, Hot Water, Compressed Air, any other process fluid / chemical energy /Mechanical energy or Electrical energy. For complete procedure kindly refer Procedure Document No. TPSMS/CSP/LOTO/001 REV 01 available on official website of Tata Power (www.tatapower.com)

5.2 Excavation Safety (Shoring and Sloping) Procedure

This procedure is developed to cover the safe practices required for shoring and sloping in excavation and trenching jobs. This procedure is developed to establish mandatory requirements for practices to protect personnel, property and equipment from hazards associated with above activities. For complete procedure kindly refer Procedure Document No TPSMS/CSP/EXS/002 REV 01 available on official website of Tata Power (www.tatapower.com)

5.3 Confined Space Entry Procedure

This procedure outlines the steps required to perform the confined space entry and to protect personnel from the hazards of entering and conducting operations in confined spaces. For complete procedure kindly refer Procedure Document No –TPSMS/CSP/CSE/003 REV 01 available on official website of Tata Power (www.tatapower.com)

The Tata Power Company Ltd		<i>Safety Terms and Condition</i>
<i>Document No. TPSMS/GSR/STC/009 REV 02</i>		<i>Date of Issue: 19/09/2019</i>

5.4 Working at Height Procedure

This procedure describes the rules and procedures to protect employees from the hazards of working at heights.

This procedure is developed to cover the safe practices required for Working at Heights. This procedure is developed to establish mandatory requirements for practices to protect personnel from hazards associated in this area. For complete procedure kindly refer Procedure Document No –TPSMS/CSP/WAH/004 REV 01 available on official website of Tata Power (www.tatapower.com)

5.5 Heavy Equipment Movement Safety Procedure

Heavy equipment lifting and movement is an activity involving loading, unloading, storage and movement from one place to another including lifting and erection or repairing of equipment with cranes or hoists. Material, machinery and equipment handling operations are being carried out by large capacity cranes and hoists, which make the job safer and faster. This procedure addresses the hazards and precautions associated with such equipment and their use. For complete procedure kindly refer Procedure Document No –TPSMS/CSP/HEMS/005 REV 01 available on official website of Tata Power (www.tatapower.com)

5.6 Mobile Crane Safety Procedure

Mobile cranes are responsible for many incidents, injuries. Falling loads from mobile cranes pose a severe hazard to operators and nearby workers and property. Many types of cranes, hoists, and rigging devices are used for lifting and moving materials. To maintain safe, appropriate standards has to be adhered to and only qualified and licensed individuals shall operate these devices. For complete procedure kindly refer Procedure Document No –TPSMS/CSP/MCS/006 REV 01.

5.7 Scaffold Safety Procedure

This procedure is developed to provide information on the safe erection, use, dismantling and maintenance of access scaffolding in the workplace. It is developed to establish mandatory requirements for practices to protect personnel from hazards associated with erection, use and dismantling of scaffolds. For complete procedure kindly refer Procedure Document No –TPSMS/CSP/SCAF/007 REV 01 available on official website of Tata Power (www.tatapower.com)

The Tata Power Company Ltd		<i>Safety Terms and Condition</i>
<i>Document No. TPSMS/GSR/STC/009 REV 02</i>		<i>Date of Issue: 19/09/2019</i>

5.8 Electrical Safety Procedure

The objective of these standards is to specify minimum mandatory requirements and advisory guidance for identifying and controlling hazards to ensure 'Zero Harm' with regard to operation maintenance and testing of electrical equipment. For complete procedure kindly refer Procedure Document No- TPSMS/CSP/ELEC/010 REV 01 available on official website of Tata Power (www.tatapower.com)

5.9 Job Safety Analysis (JSA) Procedure

This objective of this procedure is to have a task based risk assessment process in place that identifies, evaluates and controls the risks associated with work activities, and as a result, prevents those involved in the task or those potentially affected by the task, from being harmed. For complete procedure kindly refer Procedure Document No- TPSMS/CSP/JSA/009 REV 01 available on official website of Tata Power (www.tatapower.com)

5.10 Fire Safety Management Procedure

Objective of This standard is to specify the minimum mandatory requirements and advisory guidelines to ensure prevention of fire related incidents and managing / controlling their impacts if they do occur. For complete procedure kindly refer Procedure Document No- TPSMS/CSP/FSM/011 REV 01

5.11 Permit To Work Procedure

Given the inherent hazards of the power generation and distribution industry, a significant number of TATA POWER operations and installations are critical. Work Permit (WP) System is an essential element in controlling the workplace risks in an effective manner. For complete procedure kindly refer Procedure Document No –TPSMS/CSP/PTW/008 REV 01 available on official website of Tata Power (www.tatapower.com)

The Tata Power Company Ltd		<i>Safety Terms and Condition</i>
<i>Document No. TPSMS/GSR/STC/009 REV 02</i>		<i>Date of Issue: 19/09/2019</i>

5.12 Lift (Elevator) Safety Procedure

To provide safe operating procedure for taking control of lift car before entering and existing the pit of OTIS make elevators. For complete procedure kindly refer Procedure Document No – TPSMS/GSP/LIFT/001 REV 01 available on official website of Tata Power (www.tatapower.com)

5.13 Working on conveyor belt Procedure

This procedure is developed to cover the safe practices required for Working on live equipment and to protect personnel from hazards associated with it. For complete procedure kindly refer Procedure Document No – TPSMS/GSP/CONV/002 REV 01 available on official website of Tata Power (www.tatapower.com)

5.14 Handling Hazardous Materials Procedure

This Procedure is developed to provide procedure for recycling and / or safe disposal of used / waste batteries in compliance with all legislation. For complete procedure kindly refer Procedure Document No-TPSMS/GSP/HAZM/003 REV 01 available on official website of Tata Power (www.tatapower.com)

5.15 Material Handling and Storage Procedure

The purpose of this document is to provide procedures to assist the safe handling of materials (manual handling and mechanical handling). For complete procedure kindly refer Procedure Document No – TPSMS/GSP/MATL/004 REV 01 available on official website of Tata Power (www.tatapower.com)

5.16 Contractor Safety Management Procedure

The purpose of this document is to engage with contractors in a way to create safe work environment for everyone working for Tata Power. For complete procedure kindly refer Procedure Document No – TPSMS/GSP/CSM/015 REV 01 available on official website of Tata Power (www.tatapower.com)

The Tata Power Company Ltd		<i>Safety Terms and Condition</i>
<i>Document No. TPSMS/GSR/STC/009 REV 02</i>		<i>Date of Issue: 19/09/2019</i>

The above procedures will be updated periodically and the updated version of the procedures as well as any additional critical procedure will be available on official website of Tata Power (www.tatapower.com) for your reference.

5. Training and Capability Building

Safety Training and capability building of workforce is a major component of safety management program. All training required must be provided and documented as specified by Tata Power and Indian Regulations. Tata Power Safety Manager will audit contractors training and related documentation to assure its adequacy.

6.1 Tata Power Site Safety Orientation

All Tata Power contractor and subcontractor workforce is required to attend Tata Power Site Safety Orientation Training to receive a Safety Training Card, which is required to obtain a Gate Pass to the site, prior to entry.

This Safety Orientation Course will be for duration of minimum half day. The information provided during the orientation will include, but is not limited to following:

1. Job rules, personal safety and conduct
2. Hazards reporting
3. Reporting of injuries
4. Emergency procedures
5. Safety Activities and Program including disciplinary measure and incentives.
6. Critical safety procedure relevant to the job

6.2 Capability Building

Appropriate training such as L1, L2 & L3 is given to ensure that a jobholder, either supervisor or worker, is competent to do his/her job safely. The skill training is provided through TPSDI and other agencies authorized by Tata Power on the list of 15 procedures mentioned under safety procedure.

Contractor shall ensure that concerned workmen are provided with adequate training before he/she is allowed to execute the work.

An evaluation test will be conducted after the completion of the training. Those workmen employee who meet the minimum required competency will be provided with Gold Card which is valid for 3 years, post which the workmen has to reappear for the assessment. If the workman is not able to qualify the assessment, he/she will be given 3 additional attempts to clear in 3 month timeframe failing which he/she will not be allowed to work on high risk jobs.

The Tata Power Company Ltd		<i>Safety Terms and Condition</i>
<i>Document No. TPSMS/GSR/STC/009 REV 02</i>		<i>Date of Issue: 19/09/2019</i>

6. Pre Employment and Periodic Medical check up

Contractor shall arrange to conduct a pre employment and periodic medical check-up for its entire workforce by Tata Power medical officer or Tata Power authorized medical officer. The contractor shall be able to produce the certificate prior to the employment. The contractor shall also organize to conduct periodical medical checkup (six monthly) for the following category of employees:

- Drivers (Check for Vision & Hearing)
- Equipment Operators (Check for Vision & Hearing)
- Workforce working at Height (Check for Vision, Hearing, Vertigo & Height Phobia)
- Workforce Handling the hazardous substances (Coal, ash and chemicals)
- Workforce in high decibel area (> 90 Decibel, Check for Hearing)
- Workforce, working in specific areas requiring specific medical attention should conduct the medical test as laid down in the respective Site Safety Management Plan.

7. Safety Performance Evaluation and Penalties

8.1 A certain percentage of the bill value will be retained against every running bill as safety performance retention. The amount will be released with the last invoice based on "Safety Performance score" attached in CSM-F-3 of CSM procedure. The amount is based on following table

Contract Value	Retention Amount(%)
Upto 10 Lakhs	2.5
10 – 50 lakhs	2
0.5 to 10 Cr	1.5
>10 Cr	1

8.2 Safety performance Score will be monitored by the Order Manager every month.

8.3 For the contract value of more than Rs 1 Cr or contract duration more than 12 months, the retention amount shall be released half yearly based on safety performance. For all remaining contracts, the retention amount will be released with the final bill.

8.4 In case of job stoppage due to safety violations/ unsafe observations at the site, no time extension shall be given to the contractor, if such delays are attributable to contractor.

The Tata Power Company Ltd		<i>Safety Terms and Condition</i>
<i>Document No. TPSMS/GSR/STC/009 REV 02</i>		<i>Date of Issue: 19/09/2019</i>

- 8.5 In case of fatality, limb loss or loss of property, vendor has to pay for liability, legal, statutory and additional mutually agreed settlement charges imposed by the appointed committee. This charge is over and above the retention amount.
- 8.6 The committee will finalize an amount between 5 -50 lakhs based on factors such as advise by statutory authorities, contract value and impact of accident etc.
- 8.7 Safety performance bonus 1% (limiting to 50 lakhs) of the invoice value will be considered at the end of the job if the contractual safety performance score is 100%.
- 8.8 During the progress of the work, concerned Supervisor/Engineer will visit and inspect the work site regularly and evaluate the safety performance of the contractor based on matrix attached herewith.
- 8.9 Order Manager, divisional chief and SBU head have the authority to terminate the contract in case of three consecutive serious violations.

Safety Performance Evaluation - CSM-F-3

	<u>Lead Indicators</u>	Unit Of measurement	Target	weight age
1	% of Employee certified in TPSDI/Authorized agency	%	50	10
2	CFSA score (Annexure 6.1)	Average Severity of Violations	1.49	20
3	Monthly inspection completed for Critical Equipments, lifting Tools & Tackles and hand tools used at site	%	80	5
4	Condition of tools, tackles and equipments	%	100	15
	<u>Lag Indicators</u>			
1	Number of Fatalities	No.	0	30
2	Number of Lost work day case (LWDC)	No.	0	10
3	Man-days Lost	No.	0	10

The Tata Power Company Ltd		<i>Safety Terms and Condition</i>
<i>Document No.</i> <i>TPSMS/GSR/STC/009 REV 02</i>		<i>Date of Issue:</i> <i>19/09/2019</i>

In addition to above evaluation criteria, for specific violations penalty shall be imposed on the contractors under following circumstances:

Sr No	Description of violation	Severity	Penalty /
1.	Working without Permit	5	5000/-
2.	Untrained (TPSDI) worker on high-risk jobs.	5	5000/-
3.	Unhygienic/Bad condition of PPE	2	250/-
4.	Not following Tata Power Procedure & Standard	4	2000/-
5.	Unsafe Act/Condition of Severity 4	4	2000/-
6.	Unsafe Act/Condition of Severity 5	5	5000/-
7.	No Earthing of Electrical equipment	5	5000/-
8.	Damaged welding cable	5	5000/-
9.	Violation of Positive Isolation Procedure (LOTO Not followed)	5	5000/-
10.	ELCB of more than 30 mA/ELCB not working	5	5000/-
11.	On/Off switch of welding m/c not working	5	5000/-
12.	Electric cable tied with metal wire	5	5000/-
13.	Leakage found DA hose / cylinder	5	5000/-
14.	Use of LPG	5	5000/-
15.	Use of Three-wheeler at the work site.	5	5000/-
16.	Starting the job without Tool Box Talk	5	5000/-
17.	Spatter falling on DA hose / Gas-line/ pathways / Equipment	5	5000/-
18.	No safety latch in crane hook	5	5000/-
19.	Load raised or swung over people or occupied areas of buildings	5	5000/-
20.	Persons standing in swing area of construction equipments.	5	5000/-
21.	Using damaged slings.	5	5000/-
22.	Unstable scaffolding/non standard Scaffolding in use	5	5000/-
23.	Handrails and mid-rails are missing	5	5000/-
24.	Safety Harness not anchored with lifeline/fixed structure	5	5000/-
25.	Fall arrestor not provided/ Not being used.	5	5000/-
26.	Double life line not used for working at height	5	5000/-
27.	No rubber mat in DB room	4	2000/-
28.	Water found accumulated in DB room/near welding machine.	4	2000/-
29.	Inserting electric cables into socket, without using plug.	4	2000/-
30.	Use of damaged electrical cable/two core cables.	4	2000/-
31.	Inflammable material found in D.B Room./ welding areas.	4	2000/-
32.	Loose material falling into excavated pit	4	2000/-
33.	Water logging into excavated pit	4	2000/-
34.	No / inadequate Barricade	4	2000/-

Sr No	Description of violation	Severity	Penalty /
35.	Undercut / cave-in found on sides of excavated pits	4	2000/
36.	Grinding wheel/ Coupling/ Piling winch/other rotating parts without guard	4	2000/
37.	The HMV/Mobile Crane operator does not having a valid HMV driving license.	4	2000/
38.	The loading area is not leveled properly.	4	2000/
39.	Ladder not anchored at top	4	2000/
40.	Opening found in working platform of scaffolding/floor	4	2000/
41.	Inadequate illumination at the working area	4	2000/
42.	Loose material lying on Gantry ,platform	4	2000/
43.	Cleaning body with Compressed Air.	3	500/-
44.	Gas Cylinders using without cap.	3	500/
45.	Gas Cylinders stored without securing	3	500/
46.	Bringing inside any other chemicals, apart from approved by Safety dept.	3	500/
47.	Using drum for sitting or accessing height.	3	500/
48.	Misusing emergency facilities like fire hydrant line/ hose box/ spray system/ eye wash etc.	3	500/
49.	No provision of Safety net where falling materials or tools may occurs	3	500/
50.	Taking electrical supply from non designated outlet (other than socket).	3	500/
51.	Restricted gangways due to unwanted materials.	3	500/
52.	Not reporting incident.	3	500/
53.	Entering into restricted area like switch yard/ hazardous storage etc.	3	500/
54.	Work without supervision	3	500/
55.	Parking of vehicle without applying wheel choke at right front-front and left rear-rear wheels other than passengers cars.	3	500/
56.	Vehicle without helper or co-driver.	3	500/
57.	Not wearing florescent safety jacket at site.	3	500/
58.	People travelling in load body of vehicle.	3	500/
59.	Parking of vehicles at non designated area.	3	500/
60.	Shifting heavy materials without guide ropes.	3	500/
61.	Using other than 24V lamp inside the confined space/Use of other than 24V lamps.	3	500/
62.	Angular/ starch loading/ lifting with Crane or hoist.	3	500/
63.	By passing the limit switch/ Safety Interlock.	3	500/
64.	Housekeeping activities on road without proper barricade.	3	500/

Sr No	Description of violation	Severity	Penalty /
65.	Trying to board or alit from running vehicle.	3	500/-
66.	Cylinder Valves of Gas cylinders not closed when not in use.	3	500/-
67.	Flash-back arrester not used.	3	500/-
68.	Trolley wheel found damaged.	3	500/-
69.	Guy ropes of required length on both sides of object are not used during movement with load.	3	500/-
70.	Scotch block/wedge not provide when the vehicle is parked.	3	500/-
71.	Suitable Trolley not provided to hold the cylinders.	3	500/-
72.	Locked First Aid box	3	500/-
73.	Caution boards, danger signs (luminescent /red) along with emergency contact number are not found displayed.	3	500/-
74.	Person found jumping barricading tape	3	500/-
75.	Stacking of pipes, pile casing , drums without chock blocks/wedges	3	500/-
76.	The terrain on which Heavy Equipment/Machinery moves is not reasonably hard.	3	500/-
77.	Without Safety Helmet at working sites	4	250/-
78.	Without Crash Helmet (on bikes)	4	500/-
79.	Without Full body double lanyard Safety Harness (for work at height)	5	5000/-
80.	Without Hand gloves - Material Handling, Welding, Cutting,	4	100/-
81.	Without Safety goggles/ face shield - Welding/Cutting /Grinding	5	5000/-
82.	Handling Chemical without PVC Apron	5	5000/-
83.	Smoking in prohibited area (Closed Go-downs, Storage of flammable material, Storage of Gas cylinders)	5	1000/-
84.	Sleeping at Work Place	3	100/-
85.	Driving beyond speed limit	3	1000/-
86.	Seat Belt While Driving (for front seat passengers and driver)	3	500/-
87.	Driving without license	4	1000/-
88.	Heavy Commercial vehicles without reverse horn	3	500/-
89.	Non functional Head light/ tail light and side indicators	3	100/-
90.	Using Mobile Phone During Driving	5	5000/-
91.	Poor visibility of registration number/ without registration number	3	100/-
92.	Broken/ without Side view mirror	3	100/-
93.	Over speeding above specified limit	3	500/-
94.	Broken/ Without Pressure gauge on Oxygen/ LPG / Acetylene cylinder.	3	500/-

The Tata Power Company Ltd		<i>Safety Terms and Condition</i>
<i>Document No. TPSMS/GSR/STC/009 REV 02</i>		<i>Date of Issue: 19/09/2019</i>

Sr No	Description of violation	Severity	Penalty /
95.	Without Flash back arrestor on Industrial Acetylene & Oxygen cylinders.	5	5000/-
96.	Spillage of hazardous material/chemicals during transportation	4	2000/-
97.	Electrical equipment without Earthing/ ELCB/ Double Insulation Cable.	5	5000/-
98.	Lifting Tools & Tackles used without/ expired Test Certificates.	5	5000/-
99.	Housekeeping repeatedly not maintained		
100.	<ul style="list-style-type: none"> • First Time 	3	Warning
101.	<ul style="list-style-type: none"> • Second Time 	4	1000/-
102.	<ul style="list-style-type: none"> • Third Time 	5	5000/-
103.	Serious Violation Of House Keeping (after 1 st or 2 nd warning to be decided by Project Manager depending on the severity)		Rs.10000/- and above
104.	Repeat Violation of same nature	5	5X Violation



**TATA CODE OF CONDUCT
2015**



LEADERSHIP THAT INSPIRES

For over 100 years, the Tata group has been led by visionaries who have stayed true to the vision of the founder, Jamsetji Tata.

A vision that placed the greater good of society at par with business growth.

A vision that put into practice pioneering social initiatives that changed the way responsible business was run.

And a vision that brought into the group a strong social conscience.



We do not claim to be more unselfish, more generous or more philanthropic than other people. But we think we started on sound and straightforward business principles, considering the interests of the shareholders our own, and the health and welfare of the employees, the sure foundation of our success.

Jamsetji Tata
Founder of the Tata group
Chairman (1868 – 1904)

CONTENTS

Foreword	3
A Our values.....	4
B Scope and purpose of this Code.....	5
C Our core principles.....	7
D Our employees.....	9
E Our customers.....	18
F Our communities and the environment.....	21
G Our value-chain partners.....	23
H Our financial stakeholders.....	25
I Governments.....	27
J Our group companies.....	29
Raising concerns	30
Accountability	31
Acknowledgement sheet	33

FOREWORD

Tata companies have consistently adhered to the values and ideals articulated by the Founder for over 150 years. The Tata Code of Conduct was first formalized by Mr Ratan Tata. It articulates the Group's values and ideals that guide and govern the conduct of our companies as well as our colleagues in all matters relating to business. Today, the Code is a bedrock on which we base our individual, as well as leadership commitments to core Tata values.

The Tata Code of Conduct outlines our commitment to each of our stakeholders, including the communities in which we operate, and is our guiding light when we are sometimes faced with business dilemmas that leave us at ethical crossroads. The Code is also dynamic in that it has been periodically refreshed in order to remain contemporary and contextual to the changes in law and regulations. However it remains unaltered at its core.

Our stellar reputation and success as a business entity has been defined by the powerful commitment and adherence to the core values and principles expressed in this Code, by all our employees, directors and partners. I trust every Tata colleague and Tata company will continue to not only comply with the laws and regulations that govern our business interests around the world, but will continue to set new standards of ethical conduct that will generate deep respect and inspire emulation by others.

N. Chandrasekaran

21st February, 2017



A. OUR VALUES

TATA has always been values-driven. The five core values that underpin the way we conduct our business activities are:



These universal values serve as the foundation for the Tata Code of Conduct. They find expression within the value system of every Tata company.

B. SCOPE AND PURPOSE OF THIS CODE

1. This Code sets out how we behave with:
 - our employees, or those who work with us;
 - our customers;
 - the communities and the environment in which we operate;
 - our value-chain partners, including suppliers and service providers, distributors, sales representatives, contractors, channel partners, consultants, intermediaries and agents;
 - our joint-venture partners or other business associates;
 - our financial stakeholders;
 - the governments of the countries in which we operate; and
 - our group companies.
2. In this Code, “we or us” means our company, our executive directors, officers, employees and those who work with us, as the context may require.
3. The term “our group companies” in this Code typically means companies Tata Sons intends for this Code to apply to, and / or to whom Tata Sons has issued this Code.
4. This Code sets out our expectations of all those who work with us. We also expect those who deal with us to be aware that this Code underpins everything we do, and in order to work with us they need to act in a manner consistent with it.

REMEMBER...

It is our commitment to protect our reputation and our brand equity by adhering to the values and principles set out in this Code. By doing so, we strengthen our unique culture and identity.

OUR CORE PRINCIPLES



The Tata philosophy of management has always been, and is today more than ever, that corporate enterprises must be managed not merely in the interests of their owners, but equally in those of their employees, of the consumers of their products, of the local community and finally of the country as a whole.

J.R.D. Tata

Chairman, Tata Sons (1938 – 1991)

C. OUR CORE PRINCIPLES

1. We are committed to operating our businesses conforming to the highest moral and ethical standards. We do not tolerate bribery or corruption in any form. This commitment underpins everything that we do.
2. We are committed to good corporate citizenship. We treat social development activities which benefit the communities in which we operate as an integral part of our business plan.
3. We seek to contribute to the economic development of the communities of the countries and regions we operate in, while respecting their culture, norms and heritage. We seek to avoid any project or activity that is detrimental to the wider interests of the communities in which we operate.
4. We shall not compromise safety in the pursuit of commercial advantage. We shall strive to provide a safe, healthy and clean working environment for our employees and all those who work with us.
5. When representing our company, we shall act with professionalism, honesty and integrity, and conform to the highest moral and ethical standards. In the countries we operate in, we shall exhibit culturally appropriate behaviour. Our conduct shall be fair and transparent and be perceived as fair and transparent by third parties.
6. We shall respect the human rights and dignity of all our stakeholders.
7. We shall strive to balance the interests of our stakeholders, treating each of them fairly and avoiding unfair discrimination of any kind.
8. The statements that we make to our stakeholders shall be truthful and made in good faith.
9. We shall not engage in any restrictive or unfair trade practices.
10. We shall provide avenues for our stakeholders to raise concerns or queries in good faith, or report instances of actual or perceived violations of our Code.
11. We shall strive to create an environment free from fear of retribution to deal with concerns that are raised or cases reported in good faith. No one shall be punished or made to suffer for raising concerns or making disclosures in good faith or in the public interest.
12. We expect the leaders of our businesses to demonstrate their commitment to the ethical standards set out in this Code through their own behaviour and by establishing appropriate processes within their companies.
13. We shall comply with the laws of the countries in which we operate and any other laws which apply to us. With regard to those provisions of the Code that are explicitly dealt with under an applicable law or employment terms, the law and those terms shall take precedence. In the event that the standards prescribed under any applicable law are lower than that of the Code, we shall conduct ourselves as per the provisions of the Code.

REMEMBER...

“Good faith” means having a reasonable belief that the information you have provided is truthful. It does not mean having ‘all the evidence’ about the potential violation or case reported.

OUR EMPLOYEES



Once you got the best people, the people who shared our values and ideals, we left them free to act on their own. We do not fetter them. We encourage them and give them opportunities for leadership.

J.R.D. Tata

Chairman, Tata Sons (1938 – 1991)

D. OUR EMPLOYEES

Equal opportunity employer

1. We provide equal opportunities to all our employees and to all eligible applicants for employment in our company. We do not unfairly discriminate on any ground, including race, caste, religion, colour, ancestry, marital status, gender, sexual orientation, age, nationality, ethnic origin, disability or any other category protected by applicable law.
2. When recruiting, developing and promoting our employees, our decisions will be based solely on performance, merit, competence and potential.
3. We shall have fair, transparent and clear employee policies which promote diversity and equality, in accordance with applicable law and other provisions of this Code. These policies shall provide for clear terms of employment, training, development and performance management.

Q&A

A job requirement entails extensive travel. One of the candidates has excellent relevant experience and qualifications. However, this candidate is a single parent. As a result, I feel such a situation would significantly hinder this candidate's ability to cope with the job requirement. What should I do?

In accordance with the Code, the decision to recruit an employee should be based upon merit. We cannot make a presumption that the candidate would not be able to meet the travel requirements of the job. All eligible candidates should be provided with equal opportunity to demonstrate or justify that they can cope with the travel requirements of the job. Being a single parent cannot be a ground to be discriminated against at any stage of recruitment or ongoing employment in our company.

REMEMBER...

We do not tolerate harassment in any form and therefore we expect every employee to discourage such misdemeanours in the workplace.

Dignity and respect

4. Our leaders shall be responsible for creating a conducive work environment built on tolerance, understanding, mutual cooperation and respect for individual privacy.
5. Everyone in our work environment must be treated with dignity and respect. We do not tolerate any form of harassment, whether sexual, physical, verbal or psychological.
6. We have clear and fair disciplinary procedures, which necessarily include an employee's right to be heard.
7. We respect our employees' right to privacy. We have no concern with their conduct outside our work environment, unless such conduct impairs their work performance, creates conflicts of interest or adversely affects our reputation or business interests.

Human rights

8. We do not employ children at our workplaces.
9. We do not use forced labour in any form. We do not confiscate personal documents of our employees, or force them to make any payment to us or to anyone else in order to secure employment with us, or to work with us.

Bribery and corruption

10. Our employees and those representing us, including agents and intermediaries, shall not, directly or indirectly, offer or receive any illegal or improper payments or comparable benefits that are intended or perceived to obtain undue favours for the conduct of our business.

REMEMBER...

Violation by even a single employee of any law relating to anti-bribery, anti-corruption, anti-competition, data privacy, etc. could result in severe financial penalties and cause irreparable reputational damage to the company.

Gifts and hospitality

11. Business gifts and hospitality are sometimes used in the normal course of business activity. However, if offers of gifts or hospitality (including entertainment or travel) are frequent or of substantial value, they may create the perception of, or an actual conflict of interest or an 'illicit payment'. Therefore, gifts and hospitality given or received should be modest in value and appropriate, and in compliance with our company's gifts and hospitality policy.

Freedom of association

12. We recognise that employees may be interested in joining associations or involving themselves in civic or public affairs in their personal capacities, provided such activities do not create an actual or potential conflict with the interests of our company. Our employees must notify and seek prior approval for any such activity as per the 'Conflicts of Interest' clause of this Code and in accordance with applicable company policies and law.

REMEMBER...

As a general rule, we may accept gifts or hospitality from a business associate, only if such a gift:

- has modest value and does not create a perception (or an implied obligation) that the giver is entitled to preferential treatment of any kind;
- would not influence, or appear to influence, our ability to act in the best interest of our company;
- would not embarrass our company or the giver if disclosed publicly.

The following gifts are never appropriate and should never be given or accepted:

- gifts of cash or gold or other precious metals, gems or stones;
- gifts that are prohibited under applicable law;
- gifts in the nature of a bribe, payoff, kickback or facilitation payment*;
- gifts that are prohibited by the gift giver's or recipient's organisation; and
- gifts in the form of services or other non-cash benefits (e.g. a promise of employment).

(*'Facilitation' payment is a payment made to secure or speed up routine legal government actions, such as issuing permits or releasing goods held in customs.)

Working outside employment with us

13. Taking employment, accepting a position of responsibility or running a business outside employment with our company, in your own time, with or without remuneration, could interfere with your ability to work effectively at our company or create conflicts of interest. Any such activity must not be with any customer, supplier, distributor or competitor of our company. Our employees must notify and seek prior approval for any such activity as per the 'Conflicts of Interest' clause of this Code and in accordance with applicable company policies and law.

Integrity of information and assets

14. Our employees shall not make any wilful omissions or material misrepresentation that would compromise the integrity of our records, internal or external communications and reports, including the financial statements.
15. Our employees and directors shall seek proper authorisation prior to disclosing company or business-related information, and such disclosures shall be made in

accordance with our company's media and communication policy. This includes disclosures through any forum or media, including through social media.

16. Our employees shall ensure the integrity of personal data or information provided by them to our company. We shall safeguard the privacy of all such data or information given to us in accordance with applicable company policies or law.
17. Our employees shall respect and protect all confidential information and intellectual property of our company.
18. Our employees shall safeguard the confidentiality of all third party intellectual property and data. Our employees shall not misuse such intellectual property and data that comes into their possession and shall not share it with anyone, except in accordance with applicable company policies or law.
19. Our employees shall promptly report the loss, theft or destruction of any confidential information or intellectual property and data of our company or that of any third party.

Q&A

I am an accountant in the finance department of my company. Due to my artistic skills, I received an offer to pen cartoons for a children's publication for which I would receive compensation. I plan to undertake this activity during week-ends. What should I do before accepting this offer?

Before accepting the offer, you should ascertain whether the company policies and rules require you to make a disclosure to your supervisor so that the company may determine whether your undertaking this activity adversely affects our company's interests. On confirmation from the company that it does not do so, you would be free to take up the activity. It is also your duty to bring to the attention of the company whenever there is any change in the situation you have disclosed.

20. Our employees shall use all company assets, tangible and intangible, including computer and communication equipment, for the purpose for which they are provided and in order to conduct our business. Such assets shall not be misused. We shall establish processes to minimise the risk of fraud, and misappropriation or misuse of our assets.
21. We shall comply with all applicable anti-money laundering, anti-fraud and anti-corruption laws and we shall establish processes to check for and prevent any breaches of such laws.

Insider trading

22. Our employees must not indulge in any form of insider trading nor assist others, including immediate family, friends or business associates, to derive any benefit from access to and possession of price sensitive information that is not in the public domain. Such information would include information about our company, our group companies, our clients and our suppliers.

Q&A

Our company has recently announced the launch of a new business initiative. In connection with this, your friend who is a journalist with a leading business newspaper has asked you to provide some information that he could cover in his forthcoming article. He has promised not to quote you, or reveal your identity. Should you be giving him this information?

No. You should not be sharing information of this nature with the media, even if it is assured that the source would remain anonymous. Only authorised personnel in the company are permitted to speak to the media and provide information of this nature.

Our company has a “Use of Social Media” policy that lays down the “dos and don’ts” for use of social media even if you may access such media on your own time. Why is there such a policy?

External communication is a serious matter. It must be carefully managed because information put out with reference to our company or its businesses needs to be clear, truthful and not violate any undertakings we have given to other parties. In each business there are managers nominated to authorise and make different types of statements to the outside world. These managers should be consulted about any request for information you may receive or information you think we should give out.

In using social media, in particular blogs or social networking sites, you should exercise great caution while talking about our company or the business we do. It may feel like you are chatting with friends or expressing a personal opinion but even while doing so you cannot share any confidential information of our company.

REMEMBER...

We must respect the property rights of others by never misusing their assets, intellectual property or trade secrets, including the copying or downloading of unauthorised software, trademarks, copyrighted material or logos. We should never make unauthorised copies of computer software programs or use unlicensed personal software on company computers.

Prohibited drugs and substances

23. Use of prohibited drugs and substances creates genuine safety and other risks at our workplaces. We do not tolerate prohibited drugs and substances from being possessed, consumed or distributed at our workplaces, or in the course of company duties.

Conflicts of interest

24. Our employees and executive directors shall always act in the interest of our company and ensure that any business or personal association *including close personal relationships* which they may have, does not create a conflict of interest with their roles and duties in our company or the operations of our company. Further, our employees and executive directors shall not engage in any business, relationship or activity, which might conflict with the interest of our company or our group companies.

25. Should any actual or potential conflicts of interest arise, the concerned person must immediately report such conflicts and seek approvals as required by applicable law and company policy. The competent authority shall revert to the employee within a reasonable time as defined in our company's policy, so as to enable the concerned employee to take necessary action as advised to resolve or avoid the conflict in an expeditious manner.
26. In the case of all employees other than executive directors, the Chief Executive Officer / Managing Director shall be the competent authority, who in turn shall report such cases to the Board of Directors on a quarterly basis. In case of the Chief Executive Officer / Managing Director and executive directors, the Board of Directors of our company shall be the competent authority.

Q&A

You are responsible for maintaining our company's customer database. One of your friends is starting a business venture and requests you to share a few particulars from this database for marketing purposes of his business. He assures you that he would keep the data as well as his source confidential. Should you do so?

No. You should respect the confidentiality of customer information and not share any part of the database with any person without due authorisation.

You have access to revenue numbers of different business units of our company. While having a conversation with you over evening drinks, your friend enquires about the financial performance of our company. You do not share detailed information with your friend, but share approximate revenue figures. Is this conduct of yours correct?

No, it is not. You are not permitted to share financial information of our company with others who do not need to know this information. Financial information should always be safeguarded and disclosed only on a need-to-know basis after obtaining requisite approvals. Sharing of any price sensitive information that is not generally available with the public could also lead to violation of applicable insider trading laws.

27. Notwithstanding such or any other instance of conflict of interest that exists due to historical reasons, adequate and full disclosure by interested employees shall be made to our company's management. At the time of appointment in our company, our employees and executive directors shall make full disclosure to the competent authority, of any interest leading to an

actual or potential conflict that such persons or their immediate family (including parents, siblings, spouse, partner, children) or persons with whom they enjoy close personal relationships, may have in a family business or a company or firm that is a competitor, supplier, customer or distributor of, or has other business dealings with, our company.

REMEMBER...

A conflict of interest could be any known activity, transaction, relationship or service engaged in by an employee, his/her immediate family (including parents, siblings, spouse, partner, and children), relatives or a close personal relationship, which may cause concern (based upon an objective determination) that the employee could not or might not be able to fairly perform his/her duties to our company.

Examples of Potential Conflicts of Interest

A conflict of interest, actual or potential, arises where, directly or indirectly, an employee or executive director:

- (a) engages in a business, activity or relationship with anyone who is party to a transaction with our company;
- (b) is in a position to derive an improper benefit, personally or for any family member or for any person in a close personal relationship, by making or influencing decisions relating to any transaction;
- (c) conducts business on behalf of our company or is in a position to influence a decision with regard to our company's business with a supplier or customer where a relative of, or a person in close personal relationship with, an employee or executive director is a principal officer or representative, resulting in a personal benefit or a benefit to the relative;
- (d) is in a position to influence decisions with regard to award of benefits such as increase in salary or other remuneration, posting, promotion or recruitment of a relative or a person in close personal relationship employed in our company or any of our group companies;
- (e) undertakes an activity by which the interest of our company or our group companies can be compromised or defeated; or
- (f) does anything by which an independent judgement of our company's or our group companies' best interest cannot be exercised.

28. If there is a failure to make the required disclosure and our management becomes aware of an instance of conflict of interest that ought to have been disclosed by an employee or executive director, our management shall take a serious view of the

matter and consider suitable disciplinary action as per the terms of employment. In all such matters, we shall follow clear and fair disciplinary procedures, respecting the employee's right to be heard.

Examples of activities normally approved (post-disclosure) as per applicable company policy

Acceptance of a position of responsibility (whether for remuneration or otherwise) in the following cases would typically be permitted, provided the time commitments these demand do not disturb or distract from the employee's primary duties and responsibilities in our company, and are promptly disclosed to the relevant competent authority:

- (a) Directorships on the Boards of any of our group companies, joint ventures or associate companies.
- (b) Memberships/positions of responsibility in educational/professional bodies, where such association will promote the interests of our company.
- (c) Memberships or participation in government committees/bodies or organisations.

Q&A

You are in a relationship with a colleague who has been recently moved into your team and would now be reporting to you. What should you do?

Romantic or close personal relationships with another employee where a reporting relationship exists and one is responsible for evaluating the other's performance, is likely to create a conflict of interest. In such a situation, you would need to report the potential conflict to your supervisor.

Your company is submitting a proposal to a company in which you were previously employed. You have confidential information pertaining to your previous employer, which you believe will help your present employer in winning the contract. Should you share this information?

No. You should not share this information with your company since it relates to confidential information of a third party. Your company respects its employees' duty to protect confidential information that they may have relating to their previous employers.

You are the purchasing manager in the procurement department of your company. You receive an invitation from a supplier to attend a premier sporting event as her guest. This particular supplier is one of the vendors who has submitted a proposal for an open tender issued by your company. Should you accept the invitation?

No. You should not accept the invitation in this instance. Since you are in a key decision-making role for the tender, any unusual benefit that you receive could be perceived as an inducement that could compromise your objectivity.

OUR CUSTOMERS



We have continued to enjoy prosperity, even with adverse times to fight against. Our relations with all concerned are the most friendly. We have maintained the same character for straight-forward dealing with our constituents and customers. Our productions have continued to be of the same high quality, and therefore command the best reputation and realise the highest prices. ... I mention these facts only to point out that with honest and straight-forward business principles, close and careful attention to details, and the ability to take advantage of favourable opportunities and circumstances, there is a scope for success.

Jamsetji Tata

Founder of the Tata group
Chairman, Tata Sons (1868 – 1904)

E. OUR CUSTOMERS

Products and services

1. We are committed to supplying products and services of world-class quality that meet all applicable standards.
2. The products and services we offer shall comply with applicable laws, including product packaging, labelling and after-sales service obligations.
3. We shall market our products and services on their own merits and not make unfair or misleading statements about the products and services of our competitors.

Export controls and trade sanctions

4. We shall comply with all relevant export controls or trade sanctions in the course of our business.

Fair competition

5. We support the development and operation of competitive open markets and the liberalisation of trade and investment in each country and market in which we operate.
6. We shall not enter into any activity constituting anti-competitive behaviour such as abuse of market dominance, collusion, participation in cartels or inappropriate exchange of information with competitors.
7. We collect competitive information only in the normal course of business and obtain the same through legally permitted sources and means.

Dealings with customers

8. Our dealings with our customers shall be professional, fair and transparent.
9. We respect our customers' right to privacy in relation to their personal data. We shall safeguard our customers' personal data, in accordance with applicable law.

Q&A

You are the Regional Sales Manager of our company. You have become a member of an “informal group”, on an instant messaging service, whose members are the regional sales heads of our company’s competitors. The administrator of the group has requested an in-person meeting to informally discuss market conditions and brainstorm on “pricing strategy” from an industry perspective. What should you do?

Any meeting with competitors, especially to discuss “pricing strategy”, could be an attempt to promote an anti-competitive practice or manipulate prices. You should respond by declining this invitation and exiting the “informal group”. You should also report this incident to your supervisor and your Legal department.

You are attending a customer meeting with a colleague, and your colleague makes an untruthful statement about the company’s services. What should you do?

You should assist your colleague in correcting the inaccuracy during the meeting if possible. If this is not possible, raise the issue with your colleague after the meeting to enable him/her or the company to correct any misrepresentation made to the customer.

While working on a customer project, you receive a call from your colleague. He used to manage that customer account before you took over his role. He recalls that he had worked with the customer on developing a new ordering system which he thinks would be beneficial for another customer and requests you to send him the project details. What should you do?

You must not share this information without specific approval of the customer; you are not permitted to use a customer’s assets, including software, for another customer or for any personal use.

REMEMBER...

Striving for excellence in the standards of our work and in the quality of our goods and services is a core Tata value. It is the unwavering practice of this value that builds and sustains customer trust in our brand.

OUR COMMUNITIES AND THE ENVIRONMENT



In a free enterprise, the community is not just another shareholder in business but is in fact the very purpose of its existence.

Jamsetji Tata

Founder of the Tata group
Chairman, Tata Sons (1868 – 1904)

F. OUR COMMUNITIES AND THE ENVIRONMENT

Communities

1. We are committed to good corporate citizenship, and shall actively assist in the improvement of the quality of life of the people in the communities in which we operate.
2. We engage with the community and other stakeholders to minimise any adverse impact that our business operations may have on the local community and the environment.
3. We encourage our workforce to volunteer on projects that benefit the communities in which we operate, provided the principles of this Code, where applicable, and in particular the 'Conflicts of Interest' clause are followed.

The environment

4. In the production and sale of our products and services, we strive for environmental sustainability and comply with all applicable laws and regulations.
5. We seek to prevent the wasteful use of natural resources and are committed to improving the environment, particularly with regard to the emission of greenhouse gases, consumption of water and energy, and the management of waste and hazardous materials. We shall endeavour to offset the effect of climate change in our activities.

OUR VALUE-CHAIN PARTNERS



If we had done some of the things that some other groups have done, we would have been twice as big as we are today. But we didn't, and I would not have it any other way.

J.R.D. Tata

Chairman, Tata Sons (1938 – 1991)

(on the pace of expansion of the Tata group in the 1960s and 70s)

G. OUR VALUE-CHAIN PARTNERS

1. We shall select our suppliers and service providers fairly and transparently.
2. We seek to work with suppliers and service providers who can demonstrate that they share similar values. We expect them to adopt ethical standards comparable to our own.
3. Our suppliers and service providers shall represent our company only with duly authorised written permission from our company. They are expected to abide by the Code in their interactions with, and on behalf of us, including respecting the confidentiality of information shared with them.
4. We shall ensure that any gifts or hospitality received from, or given to, our suppliers or service providers comply with our company's gifts and hospitality policy.
5. We respect our obligations on the use of third party intellectual property and data.

Q&A

You head the procurement function in our company. You have tight budgetary constraints for a project that you are working on. In order to complete the project within the targeted costs, you intend to request your supplier to provide you an exceptional discount on this project order on the understanding that you would “make it up to him” in future orders. Would you be violating the Code?

Yes, you would. Inducement in any form, including future benefits to the supplier, could compromise your ability to act objectively and in the best interests of the company and therefore must be avoided.

REMEMBER...

Our value-chain partners would include our suppliers and service providers, distributors, sales representatives, contractors, channel partners, consultants, intermediaries and agents; joint-venture partners and other business associates.

OUR FINANCIAL STAKEHOLDERS



Ethical behaviour in business – in every sphere and with all constituents – has been the bedrock on which the Tata group has built, and operates, its enterprises. This has been an article of faith for the group ever since its inception, a fundamental element of our cherished heritage and the essence of our way of life.

Ratan Tata

Chairman, Tata Sons (1991 – 2012)

H. OUR FINANCIAL STAKEHOLDERS

1. We are committed to enhancing shareholder value and complying with laws and regulations that govern shareholder rights.
 2. We shall inform our financial stakeholders about relevant aspects of our business in a fair, accurate and timely manner and shall disclose such information in accordance with applicable law and agreements.
 3. We shall keep accurate records of our activities and shall adhere to disclosure standards in accordance with applicable law and industry standards.
-

GOVERNMENTS



Business, as I have seen it, places one great demand on you; it needs you to impose a framework of ethics, values, fairness and objectivity on yourself at all times. It is not easy to do this; you cannot impose it on yourself forcibly because it has to become an integral part of you.

Ratan Tata

Chairman, Tata Sons (1991 – 2012)

I. GOVERNMENTS

Political non-alignment

1. We shall act in accordance with the constitution and governance systems of the countries in which we operate. We do not seek to influence the outcome of public elections, nor to undermine or alter any system of government. We do not support any specific political party or candidate for political office. Our conduct must preclude any activity that could be interpreted as mutual dependence/favour with any political body or person, and we do not offer or give any company funds or property or other resources as donations to any specific political party, candidate or campaign.

Any financial contributions considered by our Board of Directors in order to strengthen democratic forces through a clean electoral process shall be extended only through the Progressive Electoral Trust in India, or by a similar transparent, duly-authorised, non-discriminatory and non-discretionary vehicle outside India.

Government engagement

2. We engage with the government and regulators in a constructive manner in order to promote good governance. We conduct our interactions with them in a manner consistent with our Code.
3. We do not impede, obstruct or improperly influence the conclusions of, or affect the integrity or availability of data or documents for any government review or investigation.

OUR GROUP COMPANIES



I do not think anyone was on par with Jamsetji as an industrial visionary. But that is not the sole reason why I have been an admirer of Jamsetji. The major reason was his sense of values, sterling values, which he imparted to this group. If someone were to ask me, what holds the Tata companies together, more than anything else, I would say it is our shared ideals and values which we have inherited from Jamsetji Tata.

J.R.D. Tata

Chairman, Tata Sons (1938 – 1991)

J. OUR GROUP COMPANIES

1. We seek to cooperate with our group companies, including joint ventures, by sharing knowledge, physical resources, human and management resources and adopting leading governance policies and practices in accordance with applicable law including adherence to competition law, where relevant.
2. We shall strive to achieve amicable resolution of any dispute between us and any of our group companies, through an appropriate dispute resolution mechanism so that it does not adversely affect our business interests and stakeholder value.
3. We shall have processes in place to ensure that no third party or joint venture uses the TATA name/brand to further its interests without proper authorisation.
4. Our Board of Directors shall consider for adoption policies and guidelines periodically formulated by Tata Sons and circulated to group companies.

Q&A

You are in the process of selecting potential vendors for an IT project in our company. In the final shortlist of two companies, one is a new start-up with limited references and a lower price-quotation, while the other is a Tata company with thirty years of implementation experience and good references, but a marginally higher quote for the same job. With all other parameters of choice being nearly equal, which company should you select for the job?

While price is undoubtedly an important criterion for decision making, it is clearly not the only one to be evaluated. You may also need to consider good customer references, proven track record and shared value systems in order to decide on your IT partner.

You are in the process of selecting potential vendors for a project. One of the three finalists is a group company. In reviewing the final proposals, you rank the group company second out of the three proposals based on pricing and total cost of ownership, and select the first-ranked vendor. Is this the right decision?

Yes. You should select the vendor that, on its own merits, is the vendor that is most appropriate for your company's requirements. You should not select a group company only because of its affiliation.

RAISING CONCERNS

We encourage our employees, customers, suppliers and other stakeholders to raise concerns or make disclosures when they become aware of any actual or potential violation of our Code, policies or law. We also encourage reporting of any event (actual or potential) of misconduct that is not reflective of our values and principles.

Avenues available for raising concerns or queries or reporting cases could include:

- immediate line manager or the Human Resources department of our company
- designated ethics officials of our company
- the 'confidential reporting' third party ethics helpline (if available)
- any other reporting channel set out in our company's 'Whistleblower' policy.

We do not tolerate any form of retaliation against anyone reporting legitimate concerns. Anyone involved in targeting such a person will be subject to disciplinary action.

If you suspect that you or someone you know has been subjected to retaliation for raising a concern or for reporting a case, we encourage you to promptly contact your line manager, the company's Ethics Counsellor, the Human Resources department, the MD/CEO or the office of the group's Chief Ethics Officer.

Q&A

My supervisor has asked me to do something which I believe may be illegal. I am afraid if I do not do what I am told, I could lose my job. Should I do it?

No. Breaking the law is never an option. Discuss the situation with your supervisor to be certain that you both understand the facts. If your concerns are not resolved, contact a higher level supervisor, the Ethics Counsellor, the Legal department or report them via the company's confidential reporting system, if available.

I feel that my supervisor is treating me unfairly for reporting a concern to the Ethics Counsellor. What should I do?

Retaliation against anyone who raises a concern is a violation of the Code. You should therefore promptly report this action of your supervisor to the Ethics Counsellor or the MD/CEO of your company or via the company's confidential reporting system, if available.

ACCOUNTABILITY

This Code is more than a set of prescriptive guidelines issued solely for the purpose of formal compliance. It represents our collective commitment to our value system and to our core principles.

Every person employed by us, directly or indirectly, should expect to be held accountable for his/her behaviour. Should such behaviour violate this Code,

they may be subject to action according to their employment terms and relevant company policies.

When followed in letter and in spirit, this Code is 'lived' by our employees as well as those who work with us. It represents our shared responsibility to all our stakeholders, and our mutual commitment to each other.

SPEAK UP...

If you are unsure whether a particular action you are about to take is consistent with the principles set forth in the Code, ask yourself:

- Could it directly or indirectly endanger someone or cause them injury?
- Is it illegal/unlawful or out of line with our policies and procedures?
- Does my conscience reject it? Does it conflict with my personal values?
- Would I feel uncomfortable if the story appeared in the media? Would it shame my company, spouse, partner, parent or child?
- Does it 'feel' wrong?

If the answer to any of these questions is "Yes", please stop and consult your reporting manager, the Ethics Counsellor, the Human Resource department, the Legal department or any member of the senior management team, to assist you in making the decision.

When faced with a dilemma: Stop, Think, Act Responsibly

NOTE

The Code does not provide a comprehensive and complete explanation of all expectations from a company standpoint or obligations from a stakeholder standpoint.

Our employees have a continuing obligation to familiarise themselves with all applicable law, group-level advisories and policies, company-level policies, procedures and work rules as relevant. For any guidance on interpretation of the Code, we may seek support from our company's Ethics Counsellor or from the group's Chief Ethics Officer, as appropriate.

All joint ventures are encouraged to adopt the Tata Code of Conduct (TCOC) or a code of conduct that incorporates all elements of the TCOC.

This version of the Tata Code of Conduct supersedes all earlier versions and associated documents and stands effective from 29th July, 2015.

For any query or clarification on the Code, please contact the office of the group's Chief Ethics Officer via email at: ethicsoffice@tata.com.



TATA CODE OF CONDUCT – 2015

I acknowledge that I have received the Tata Code of Conduct.

I have read the Tata Code of Conduct and I acknowledge that as a Tata employee, I am required to comply with the guidelines described therein and failure to do so may subject me to action as per my employment terms and relevant company policies.

If I have a concern about a violation, or a potential violation of the Tata Code of Conduct, I understand that there are channels available to me in my company to report such concerns. By making use of these channels when necessary, I will play my part in maintaining the high ethical standards to which we hold ourselves.

Signature: _____

Date: _____

Name: _____

Department: _____

Address: _____

(Please submit this declaration to your Ethics Counsellor or the Human Resource department of your company.)







For further information on the Code please contact:
 The Ethics Office,
 Tata Sons Ltd.,
 Bombay House,
 24, Homi Mody Street,
 Mumbai – 400001, India.
 Email: ethicsoffice@tata.com

CORPORATE SUSTAINABILITY POLICY

At Tata Power, our Sustainability Policy integrates economic progress, social responsibility and environmental concerns with the objective of improving quality of life. We believe in integrating our business values and operations to meet the expectations of our customers, employees, partners, investors, communities and public at large

- We will uphold the values of honesty, partnership and fairness in our relationship with stakeholders
- We shall provide and maintain a clean, healthy and safe working environment for employees, customers, partners and the community
- We will strive to consistently enhance our value proposition to the customers and adhere to our promised standards of service delivery
- We will respect the universal declaration of human rights, International Labour Organization's fundamental conventions on core labour standards and operate as an equal opportunities employer
- We shall encourage and support our partners to adopt responsible business policies, Business Ethics and our Code of Conduct Standards
- We will continue to serve our communities:
 - By implementing sustainable Community Development Programmes including through public/private partnerships in and around our area of operations
 - By constantly protecting ecology, maintaining and renewing bio-diversity and wherever necessary conserving and protecting wild life, particularly endangered species
 - By encouraging our employees to serve communities by volunteering and by sharing their skills and expertise
 - By striving to deploy sustainable technologies and processes in all our operations and use scarce natural resources efficiently in our facilities
 - We will also help communities that are affected by natural calamities or untoward incidence, or that are physically challenged in line with the Tata Group's efforts

The management will commit all the necessary resources required to meet the goals of Corporate Sustainability.



(Praveer Sinha)
CEO & Managing Director

Date: 15th June, 2018

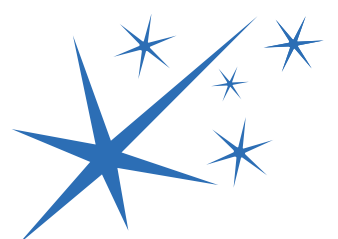

CORPORATE ENVIRONMENT POLICY

Tata Power is committed to a clean, safe and healthy environment, and we shall operate our facilities in an environmentally sensitive and responsible manner. Our commitment to environmental protection and stewardship will be achieved by:

- Complying with the requirements and spirit of applicable environmental laws and striving to exceed required levels of compliance wherever feasible
- Ensuring that our employees are trained to acquire the necessary skills to meet environmental standards
- Conserving natural resources by improving efficiency and reducing wastage
- Making business decisions that aim towards sustainable development
- Engaging with stakeholders to create awareness on sustainability



(Praveer Sinha)
CEO & Managing Director

Date: 15th June, 2018

